

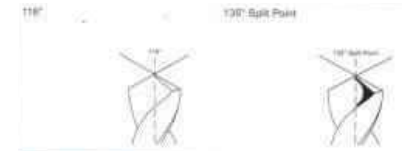

HSS Straight Shank Twist Drill DIN338

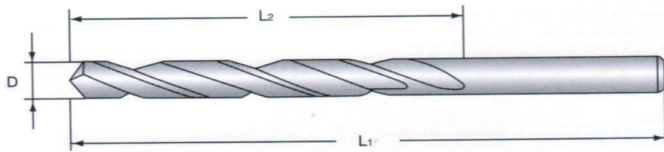

Art No.	D	L ₁	L ₂	Art No.	D	L ₁	L ₂	Art No.	D	L ₁	L ₂	Art No.	D	L ₁	L ₂
GMA10001	0.2	19	2.5	GMA10053	2	49	24	GMA10105	6.2	101	63	GMA10157	11.4	142	94
GMA10002	0.22	19	2.5	GMA10054	2.05	49	24	GMA10106	6.3	101	63	GMA10158	11.5	142	94
GMA10003	0.25	19	3	GMA10055	2.1	49	24	GMA10107	6.4	101	63	GMA10159	11.6	142	94
GMA10004	0.28	19	3	GMA10056	2.15	53	27	GMA10108	6.5	101	63	GMA10160	11.7	142	94
GMA10005	0.3	19	3	GMA10057	2.2	53	27	GMA10109	6.6	101	63	GMA10161	11.8	142	94
GMA10006	0.32	19	4	GMA10058	2.25	53	27	GMA10110	6.7	101	63	GMA10162	11.9	151	101
GMA10007	0.35	19	4	GMA10059	2.3	53	27	GMA10111	6.8	109	69	GMA10163	12	151	101
GMA10008	0.38	19	4	GMA10060	2.35	53	27	GMA10112	6.9	109	69	GMA10164	12.1	151	101
GMA10009	0.4	20	5	GMA10061	2.4	57	30	GMA10113	7	109	69	GMA10165	12.2	151	101
GMA10010	0.42	20	5	GMA10062	2.45	57	30	GMA10114	7.1	109	69	GMA10166	12.3	151	101
GMA10011	0.45	20	5	GMA10063	2.5	57	30	GMA10115	7.2	109	69	GMA10167	12.4	151	101
GMA10012	0.48	20	5	GMA10064	2.55	57	30	GMA10116	7.3	109	69	GMA10168	12.5	151	101
GMA10013	0.5	22	6	GMA10065	2.6	57	30	GMA10117	7.4	109	69	GMA10169	12.6	151	101
GMA10014	0.52	22	6	GMA10066	2.65	57	30	GMA10118	7.5	109	69	GMA10170	12.7	151	101
GMA10015	0.55	24	7	GMA10067	2.7	61	33	GMA10119	7.6	117	75	GMA10171	12.8	151	101
GMA10016	0.58	24	7	GMA10068	2.75	61	33	GMA10120	7.7	117	75	GMA10172	12.9	151	101
GMA10017	0.6	24	7	GMA10069	2.8	61	33	GMA10121	7.8	117	75	GMA10173	13	151	101
GMA10018	0.62	26	8	GMA10070	2.85	61	33	GMA10122	7.9	117	75	GMA10174	13.1	151	101
GMA10019	0.65	26	8	GMA10071	2.9	61	33	GMA10123	8	117	75	GMA10175	13.2	151	101
GMA10020	0.68	28	9	GMA10072	2.95	61	33	GMA10124	8.1	117	75	GMA10176	13.3	160	108
GMA10021	0.7	28	9	GMA10073	3	61	33	GMA10125	8.2	117	75	GMA10177	13.4	160	108
GMA10022	0.72	28	9	GMA10074	3.1	65	36	GMA10126	8.3	117	75	GMA10178	13.5	160	108
GMA10023	0.75	28	9	GMA10075	3.2	65	36	GMA10127	8.4	117	75	GMA10179	13.6	160	108
GMA10024	0.78	30	10	GMA10076	3.3	65	36	GMA10128	8.5	117	75	GMA10180	13.7	160	108
GMA10025	0.8	30	10	GMA10077	3.4	70	39	GMA10129	8.6	125	81	GMA10181	13.8	160	108
GMA10026	0.82	30	10	GMA10078	3.5	70	39	GMA10130	8.7	125	81	GMA10182	13.9	160	108
GMA10027	0.85	30	10	GMA10079	3.6	70	39	GMA10131	8.8	125	81	GMA10183	14	160	108
GMA10028	0.88	32	11	GMA10080	3.7	70	39	GMA10132	8.9	125	81	GMA10184	14.25	169	114
GMA10029	0.9	32	11	GMA10081	3.8	75	43	GMA10133	9	125	81	GMA10185	14.5	169	114
GMA10030	0.92	32	11	GMA10082	3.9	75	43	GMA10134	9.1	125	81	GMA10186	14.75	169	114
GMA10031	0.95	32	11	GMA10083	4	75	43	GMA10135	9.2	125	81	GMA10187	15	169	114
GMA10032	0.98	34	12	GMA10084	4.1	75	43	GMA10136	9.3	125	81	GMA10188	15.25	178	120
GMA10033	1	34	12	GMA10085	4.2	75	43	GMA10137	9.4	125	81	GMA10189	15.5	178	120
GMA10034	1.05	34	12	GMA10086	4.3	80	47	GMA10138	9.5	125	81	GMA10190	15.75	178	120
GMA10035	1.1	36	14	GMA10087	4.4	80	47	GMA10139	9.6	133	87	GMA10191	16	178	120
GMA10036	1.15	36	14	GMA10088	4.5	80	47	GMA10140	9.7	133	87	GMA10192	16.25	184	125
GMA10037	1.2	38	16	GMA10089	4.6	80	47	GMA10141	9.8	133	87	GMA10193	16.5	184	125
GMA10038	1.25	38	16	GMA10090	4.7	80	47	GMA10142	9.9	133	87	GMA10194	16.75	184	125
GMA10039	1.3	38	16	GMA10091	4.8	86	52	GMA10143	10	133	87	GMA10195	17	184	125
GMA10040	1.35	40	18	GMA10092	4.9	86	52	GMA10144	10.1	133	87	GMA10196	17.25	191	130
GMA10041	1.4	40	18	GMA10093	5	86	52	GMA10145	10.2	133	87	GMA10197	17.5	191	130
GMA10042	1.45	40	18	GMA10094	5.1	86	52	GMA10146	10.3	133	87	GMA10198	17.75	191	130
GMA10043	1.5	40	18	GMA10095	5.2	86	52	GMA10147	10.4	133	87	GMA10199	18	191	130
GMA10044	1.55	43	20	GMA10096	5.3	86	52	GMA10148	10.5	133	87	GMA10200	18.25	198	135
GMA10045	1.6	43	20	GMA10097	5.4	93	57	GMA10149	10.6	133	87	GMA10201	18.5	198	135
GMA10046	1.65	43	20	GMA10098	5.5	93	57	GMA10150	10.7	142	94	GMA10202	18.75	198	135
GMA10047	1.7	43	20	GMA10099	5.6	93	57	GMA10151	10.8	142	94	GMA10203	19	198	135
GMA10048	1.75	46	22	GMA10100	5.7	93	57	GMA10152	10.9	142	94	GMA10204	19.25	205	140
GMA10049	1.8	46	22	GMA10101	5.8	93	57	GMA10153	11	142	94	GMA10205	19.5	205	140
GMA10050	1.85	46	22	GMA10102	5.9	93	57	GMA10154	11.1	142	94	GMA10206	19.75	205	140
GMA10051	1.9	46	22	GMA10103	6	93	57	GMA10155	11.2	142	94	GMA10207	20	205	140
GMA10052	1.95	49	24	GMA10104	6.1	101	63	GMA10156	11.3	142	94				



HSS Straight Shank Twist Drill DIN1897

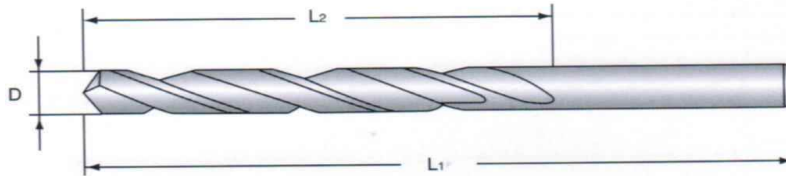

																mm
Art No.	D	L ₁	L ₂	Art No.	D	L ₁	L ₂	Art No.	D	L ₁	L ₂	Art No.	D	L ₁	L ₂	
GMA11001	1	26	6	GMA11040	4.9	62	26	GMA11079	8.8	84	40	GMA11118	12.7	102	51	
GMA11002	1.1	28	7	GMA11041	5	62	26	GMA11080	8.9	84	40	GMA11119	12.8	102	51	
GMA11003	1.2	30	8	GMA11042	5.1	62	26	GMA11081	9	84	40	GMA11120	12.9	102	51	
GMA11004	1.3	30	8	GMA11043	5.2	62	26	GMA11082	9.1	84	40	GMA11121	13	102	51	
GMA11005	1.4	32	9	GMA11044	5.3	62	26	GMA11083	9.2	84	40	GMA11122	13.1	102	51	
GMA11006	1.5	32	9	GMA11045	5.4	66	28	GMA11084	9.3	84	40	GMA11123	13.2	102	51	
GMA11007	1.6	34	10	GMA11046	5.5	66	28	GMA11085	9.4	84	40	GMA11124	13.3	107	54	
GMA11008	1.7	34	10	GMA11047	5.6	66	28	GMA11086	9.5	84	40	GMA11125	13.4	107	54	
GMA11009	1.8	36	11	GMA11048	5.7	66	28	GMA11087	9.6	89	43	GMA11126	13.5	107	54	
GMA11010	1.9	36	11	GMA11049	5.8	66	28	GMA11088	9.7	89	43	GMA11127	13.6	107	54	
GMA11011	2	38	12	GMA11050	5.9	66	28	GMA11089	9.8	89	43	GMA11128	13.7	107	54	
GMA11012	2.1	38	12	GMA11051	6	66	28	GMA11090	9.9	89	43	GMA11129	13.8	107	54	
GMA11013	2.2	40	13	GMA11052	6.1	70	31	GMA11091	10	89	43	GMA11130	13.9	107	54	
GMA11014	2.3	40	13	GMA11053	6.2	70	31	GMA11092	10.1	89	43	GMA11131	14	107	54	
GMA11015	2.4	43	14	GMA11054	6.3	70	31	GMA11093	10.2	89	43	GMA11132	14.25	111	56	
GMA11016	2.5	43	14	GMA11055	6.4	70	31	GMA11094	10.3	89	43	GMA11133	14.5	111	56	
GMA11017	2.6	43	14	GMA11056	6.5	70	31	GMA11095	10.4	89	43	GMA11134	14.75	111	56	
GMA11018	2.7	46	16	GMA11057	6.6	70	31	GMA11096	10.5	89	43	GMA11135	15	111	56	
GMA11019	2.8	46	16	GMA11058	6.7	70	31	GMA11097	10.6	89	43	GMA11136	15.25	115	58	
GMA11020	2.9	46	16	GMA11059	6.8	74	34	GMA11098	10.7	95	47	GMA11137	15.5	115	58	
GMA11021	3	46	16	GMA11060	6.9	74	34	GMA11099	10.8	95	47	GMA11138	15.75	115	58	
GMA11022	3.1	49	18	GMA11061	7	74	34	GMA11100	10.9	95	47	GMA11139	16	115	58	
GMA11023	3.2	49	18	GMA11062	7.1	74	34	GMA11101	11	95	47	GMA11140	16.25	119	60	
GMA11024	3.3	49	18	GMA11063	7.2	74	34	GMA11102	11.1	95	47	GMA11141	16.5	119	60	
GMA11025	3.4	52	20	GMA11064	7.3	74	34	GMA11103	11.2	95	47	GMA11142	16.75	119	60	
GMA11026	3.5	52	20	GMA11065	7.4	74	34	GMA11104	11.3	95	47	GMA11143	17	119	60	
GMA11027	3.6	52	20	GMA11066	7.5	74	34	GMA11105	11.4	95	47	GMA11144	17.25	123	62	
GMA11028	3.7	52	20	GMA11067	7.6	79	37	GMA11106	11.5	95	47	GMA11145	17.5	123	62	
GMA11029	3.8	55	22	GMA11068	7.7	79	37	GMA11107	11.6	95	47	GMA11146	17.75	123	62	
GMA11030	3.9	55	22	GMA11069	7.8	79	37	GMA11108	11.7	95	47	GMA11147	18	123	62	
GMA11031	4	55	22	GMA11070	7.9	79	37	GMA11109	11.8	95	47	GMA11148	18.25	127	64	
GMA11032	4.1	55	22	GMA11071	8	79	37	GMA11110	11.9	102	51	GMA11149	18.5	127	64	
GMA11033	4.2	55	22	GMA11072	8.1	79	37	GMA11111	12	102	51	GMA11150	18.75	127	64	
GMA11034	4.3	58	24	GMA11073	8.2	79	37	GMA11112	12.1	102	51	GMA11151	19	127	64	
GMA11035	4.4	58	24	GMA11074	8.3	79	37	GMA11113	12.2	102	51	GMA11152	19.25	131	66	
GMA11036	4.5	58	24	GMA11075	8.4	79	37	GMA11114	12.3	102	51	GMA11153	19.5	131	66	
GMA11037	4.6	58	24	GMA11076	8.5	79	37	GMA11115	12.4	102	51	GMA11154	19.75	131	66	
GMA11038	4.7	58	24	GMA11077	8.6	84	40	GMA11116	12.5	102	51	GMA11155	20	131	66	
GMA11039	4.8	62	26	GMA11078	8.7	84	40	GMA11117	12.6	102	51					



HSS Straight Shank Twist Drill DIN340

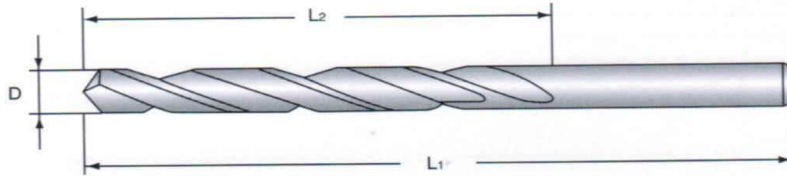

mm

Art No.	D	L1	L2	Art No.	D	L1	L2	Art No.	D	L1	L2	Art No.	D	L1	L2
GMA12001	1	56	33	GMA12042	5.1	132	87	GMA12083	9.2	175	115	GMA12124	13.3	214	140
GMA12002	1.1	60	37	GMA12043	5.2	132	87	GMA12084	9.3	175	115	GMA12125	13.4	214	140
GMA12003	1.2	65	41	GMA12044	5.3	132	87	GMA12085	9.4	175	115	GMA12126	13.5	214	140
GMA12004	1.3	65	41	GMA12045	5.4	139	91	GMA12086	9.5	175	115	GMA12127	13.6	214	140
GMA12005	1.4	70	45	GMA12046	5.5	139	91	GMA12087	9.6	184	121	GMA12128	13.7	214	140
GMA12006	1.5	70	45	GMA12047	5.6	139	91	GMA12088	9.7	184	121	GMA12129	13.8	214	140
GMA12007	1.6	76	50	GMA12048	5.7	139	91	GMA12089	9.8	184	121	GMA12130	13.9	214	140
GMA12008	1.7	76	50	GMA12049	5.8	139	91	GMA12090	9.9	184	121	GMA12131	14	214	140
GMA12009	1.8	80	53	GMA12050	5.9	139	91	GMA12091	10	184	121	GMA12132	14.25	220	144
GMA12010	1.9	80	53	GMA12051	6	139	91	GMA12092	10.1	184	121	GMA12133	14.5	220	144
GMA12011	2	85	56	GMA12052	6.1	148	97	GMA12093	10.2	184	121	GMA12134	14.75	220	144
GMA12012	2.1	85	56	GMA12053	6.2	148	97	GMA12094	10.3	184	121	GMA12135	15	220	144
GMA12013	2.2	90	56	GMA12054	6.3	148	97	GMA12095	10.4	184	121	GMA12136	15.25	227	149
GMA12014	2.3	90	56	GMA12055	6.4	148	97	GMA12096	10.5	184	121	GMA12137	15.5	227	149
GMA12015	2.4	95	62	GMA12056	6.5	148	97	GMA12097	10.6	184	121	GMA12138	15.75	227	149
GMA12016	2.5	95	62	GMA12057	6.6	148	97	GMA12098	10.7	195	128	GMA12139	16	227	149
GMA12017	2.6	95	62	GMA12058	6.7	148	97	GMA12099	10.8	195	128	GMA12140	16.25	235	154
GMA12018	2.7	100	66	GMA12059	6.8	156	102	GMA12100	10.9	195	128	GMA12141	16.5	235	154
GMA12019	2.8	100	66	GMA12060	6.9	156	102	GMA12101	11	195	128	GMA12142	16.75	235	154
GMA12020	2.9	100	66	GMA12061	7	156	102	GMA12102	11.1	195	128	GMA12143	17	235	154
GMA12021	3	100	66	GMA12062	7.1	156	102	GMA12103	11.2	195	128	GMA12144	17.25	241	158
GMA12022	3.1	106	69	GMA12063	7.2	156	102	GMA12104	11.3	195	128	GMA12145	17.5	241	158
GMA12023	3.2	106	69	GMA12064	7.3	156	102	GMA12105	11.4	195	128	GMA12146	17.75	241	158
GMA12024	3.3	106	69	GMA12065	7.4	156	102	GMA12106	11.5	195	128	GMA12147	18	241	158
GMA12025	3.4	112	73	GMA12066	7.5	156	102	GMA12107	11.6	195	128	GMA12148	18.25	247	162
GMA12026	3.5	112	73	GMA12067	7.6	165	109	GMA12108	11.7	195	128	GMA12149	18.5	247	162
GMA12027	3.6	112	73	GMA12068	7.7	165	109	GMA12109	11.8	195	128	GMA12150	18.75	247	162
GMA12028	3.7	112	73	GMA12069	7.8	165	109	GMA12110	11.9	205	134	GMA12151	19	247	162
GMA12029	3.8	119	78	GMA12070	7.9	165	109	GMA12111	12	205	134	GMA12152	19.25	254	166
GMA12030	3.9	119	78	GMA12071	8	165	109	GMA12112	12.1	205	134	GMA12153	19.5	254	166
GMA12031	4	119	78	GMA12072	8.1	165	109	GMA12113	12.2	205	134	GMA12154	19.75	254	166
GMA12032	4.1	119	78	GMA12073	8.2	165	109	GMA12114	12.3	205	134	GMA12155	20	254	166
GMA12033	4.2	119	78	GMA12074	8.3	165	109	GMA12115	12.4	205	134				
GMA12034	4.3	126	82	GMA12075	8.4	165	109	GMA12116	12.5	205	134				
GMA12035	4.4	126	82	GMA12076	8.5	165	109	GMA12117	12.6	205	134				
GMA12036	4.5	126	82	GMA12077	8.6	175	115	GMA12118	12.7	205	134				
GMA12037	4.6	126	82	GMA12078	8.7	175	115	GMA12119	12.8	205	134				
GMA12038	4.7	126	82	GMA12079	8.8	175	115	GMA12120	12.9	205	134				
GMA12039	4.8	132	87	GMA12080	8.9	175	115	GMA12121	13	205	134				
GMA12040	4.9	132	87	GMA12081	9	175	115	GMA12122	13.1	205	134				
GMA12041	5	132	87	GMA12082	9.1	175	115	GMA12123	13.2	205	134				



HSS Straight Shank Twist Drill DIN1869

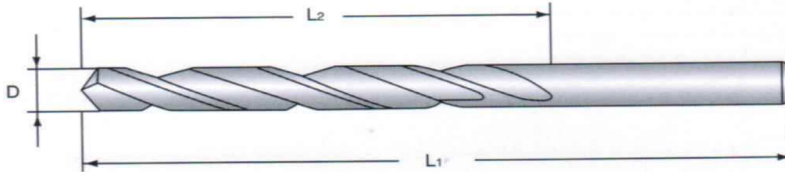

mm

Art No.	DIN1869- I			Art No.	DIN1869- II			Art No.	DIN1869- III		
	D	L ₁	L ₂		D	L ₁	L ₂		D	L ₁	L ₂
GMA13001	2.00	125	85	GMA13024	2.00	160	110	GMA13047	2.00	200	135
GMA13002	2.50	140	95	GMA13025	2.50	180	120	GMA13048	2.50	225	150
GMA13003	3.00	150	100	GMA13026	3.00	190	130	GMA13049	3.00	240	160
GMA13004	3.50	165	115	GMA13027	3.50	210	145	GMA13050	3.50	265	180
GMA13005	4.00	175	120	GMA13028	4.00	220	150	GMA13051	4.00	280	190
GMA13006	4.50	185	125	GMA13029	4.50	235	160	GMA13052	4.50	295	200
GMA13007	5.00	195	135	GMA13030	5.00	245	170	GMA13053	5.00	315	210
GMA13008	5.50	205	140	GMA13031	5.50	260	180	GMA13054	5.50	330	225
GMA13009	6.00	205	140	GMA13032	6.00	260	180	GMA13055	6.00	330	225
GMA13010	6.50	215	150	GMA13033	6.50	275	190	GMA13056	6.50	350	235
GMA13011	7.00	225	155	GMA13034	7.00	290	200	GMA13057	7.00	370	250
GMA13012	7.50	225	155	GMA13035	7.50	290	200	GMA13058	7.50	370	250
GMA13013	8.00	240	165	GMA13036	8.00	305	210	GMA13059	8.00	390	265
GMA13014	8.50	240	165	GMA13037	8.50	305	210	GMA13060	8.50	390	265
GMA13015	9.00	250	175	GMA13038	9.00	320	220	GMA13061	9.00	410	280
GMA13016	9.50	250	175	GMA13039	9.50	320	220	GMA13062	9.50	410	280
GMA13017	10.00	265	185	GMA13040	10.00	340	235	GMA13063	10.00	430	295
GMA13018	10.50	265	185	GMA13041	10.50	340	235	GMA13064	10.50	430	295
GMA13019	11.00	280	195	GMA13042	11.00	365	250	GMA13065	11.00	455	310
GMA13020	11.50	280	195	GMA13043	11.50	365	250	GMA13066	11.50	455	310
GMA13021	12.00	295	205	GMA13044	12.00	375	260	GMA13067	12.00	480	330
GMA13022	12.50	295	205	GMA13045	12.50	375	260	GMA13068	12.50	480	330
GMA13023	13.00	295	205	GMA13046	13.00	375	260	GMA13069	13.00	480	330



HSS Straight Shank Twist Drill DIN1869

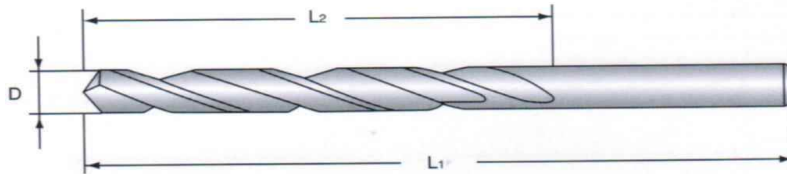

mm

Art No.	DIN1869- I			Art No.	DIN1869- II			Art No.	DIN1869- III		
	D	L ₁	L ₂		D	L ₁	L ₂		D	L ₁	L ₂
GMA13001	2.00	125	85	GMA13024	2.00	160	110	GMA13047	2.00	200	135
GMA13002	2.50	140	95	GMA13025	2.50	180	120	GMA13048	2.50	225	150
GMA13003	3.00	150	100	GMA13026	3.00	190	130	GMA13049	3.00	240	160
GMA13004	3.50	165	115	GMA13027	3.50	210	145	GMA13050	3.50	265	180
GMA13005	4.00	175	120	GMA13028	4.00	220	150	GMA13051	4.00	280	190
GMA13006	4.50	185	125	GMA13029	4.50	235	160	GMA13052	4.50	295	200
GMA13007	5.00	195	135	GMA13030	5.00	245	170	GMA13053	5.00	315	210
GMA13008	5.50	205	140	GMA13031	5.50	260	180	GMA13054	5.50	330	225
GMA13009	6.00	205	140	GMA13032	6.00	260	180	GMA13055	6.00	330	225
GMA13010	6.50	215	150	GMA13033	6.50	275	190	GMA13056	6.50	350	235
GMA13011	7.00	225	155	GMA13034	7.00	290	200	GMA13057	7.00	370	250
GMA13012	7.50	225	155	GMA13035	7.50	290	200	GMA13058	7.50	370	250
GMA13013	8.00	240	165	GMA13036	8.00	305	210	GMA13059	8.00	390	265
GMA13014	8.50	240	165	GMA13037	8.50	305	210	GMA13060	8.50	390	265
GMA13015	9.00	250	175	GMA13038	9.00	320	220	GMA13061	9.00	410	280
GMA13016	9.50	250	175	GMA13039	9.50	320	220	GMA13062	9.50	410	280
GMA13017	10.00	265	185	GMA13040	10.00	340	235	GMA13063	10.00	430	295
GMA13018	10.50	265	185	GMA13041	10.50	340	235	GMA13064	10.50	430	295
GMA13019	11.00	280	195	GMA13042	11.00	365	250	GMA13065	11.00	455	310
GMA13020	11.50	280	195	GMA13043	11.50	365	250	GMA13066	11.50	455	310
GMA13021	12.00	295	205	GMA13044	12.00	375	260	GMA13067	12.00	480	330
GMA13022	12.50	295	205	GMA13045	12.50	375	260	GMA13068	12.50	480	330
GMA13023	13.00	295	205	GMA13046	13.00	375	260	GMA13069	13.00	480	330



HSS Straight Shank Twist Drill Jobber Length

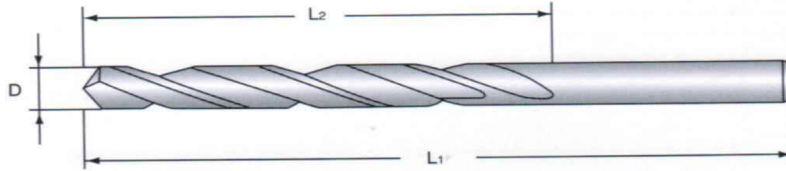

Art No.	D	L1	L2
GMA14001	1/64"	3/4"	3/16"
GMA14002	1/32"	1-3/8"	1/2"
GMA14003	3/64"	1-3/4"	3/4"
GMA14004	1/16"	1-7/8"	7/8"
GMA14005	5/64"	2"	1"
GMA14006	3/32"	2-1/4"	1-1/4"
GMA14007	7/64"	2-5/8"	1-1/2"
GMA14008	1/8"	2-3/4"	1-5/8"
GMA14009	9/64"	2-7/8"	1-3/4"
GMA14010	5/32"	3-1/8"	2"
GMA14011	11/64"	3-1/4"	2-1/8"
GMA14012	3/16"	3-1/2"	2-5/16"
GMA14013	13/64"	3-5/8"	2-7/16"
GMA14014	7/32"	3-3/4"	2-1/2"
GMA14015	15/64"	3-7/8"	2-5/8"
GMA14016	1/4"	4"	2-3/4"
GMA14017	17/64"	4-1/8"	2-7/8"
GMA14018	9/32"	4-1/4"	2-15/16"
GMA14019	19/64"	4-3/8"	3-1/16"
GMA14020	5/16"	4-1/2"	3-3/16"
GMA14021	21/64"	4-5/8"	3-5/16"
GMA14022	11/32"	4-3/4"	3-7/16"
GMA14023	23/64"	4-7/8"	3-1/2"
GMA14024	3/8"	5"	3-5/8"

Art No.	D	L1	L2
GMA14025	25/64"	5-1/8"	3-3/4"
GMA14026	13/32"	5-1/4"	3-7/8"
GMA14027	27/64"	5-3/8"	3-15/16"
GMA14028	7/16"	5-1/2"	4-1/16"
GMA14029	29/64"	5-5/8"	4-3/16"
GMA14030	15/32"	5-3/4"	4-5/16"
GMA14031	31/64"	5-7/8"	4-3/8"
GMA14032	1/2"	6"	4-1/2"
GMA14033	33/64"	6-5/8"	4-13/16"
GMA14034	17/32"	6-5/8"	4-13/16"
GMA14035	35/64"	6-5/8"	4-13/16"
GMA14036	9/16"	6-5/8"	4-13/16"
GMA14037	37/64"	6-5/8"	4-13/16"
GMA14038	19/32"	7-1/8"	5-3/16"
GMA14039	39/64"	7-1/8"	5-3/16"
GMA14040	5/8"	7-1/8"	5-3/16"
GMA14041	41/64"	7-1/8"	5-3/16"
GMA14042	21/32"	7-1/8"	5-3/16"
GMA14043	43/64"	7-5/8"	5-5/8"
GMA14044	11/16"	7-5/8"	5-5/8"
GMA14045	45/64"	7-5/8"	5-5/8"
GMA14046	23/32"	7-5/8"	5-5/8"
GMA14047	47/64"	7-5/8"	5-5/8"
GMA14048	3/4"	7-5/8"	5-5/8"



HSS Straight Shank Twist Drill Jobber Length

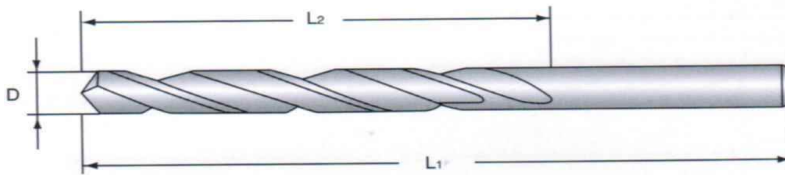

Art No.	D	L1	L2	Art No.	D	L1	L2	Art No.	D	L1	L2
GMA15001	1#	3-7/8"	2-5/8"	GMA15041	41#	2-3/8"	1-3/8"	GMA15081	A	3-7/8"	2-5/8"
GMA15002	2#	3-7/8"	2-5/8"	GMA15042	42#	2-1/4"	1-1/4"	GMA15082	B	4"	2-3/4"
GMA15003	3#	3-3/4"	2-1/2"	GMA15043	43#	2-1/4"	1-1/4"	GMA15083	C	4"	2-3/4"
GMA15004	4#	3-3/4"	2-1/2"	GMA15044	44#	2-1/8"	1-1/8"	GMA15084	D	4"	2-3/4"
GMA15005	5#	3-3/4"	2-1/2"	GMA15045	45#	2-1/8"	1-1/8"	GMA15085	E	4"	2-3/4"
GMA15006	6#	3-3/4"	2-1/2"	GMA15046	46#	2-1/8"	1-1/8"	GMA15086	F	4-1/8"	2-7/8"
GMA15007	7#	3-5/8"	2-7/16"	GMA15047	47#	2"	1"	GMA15087	G	4-1/8"	2-7/8"
GMA15008	8#	3-5/8"	2-7/16"	GMA15048	48#	2"	1"	GMA15088	H	4-1/8"	2-7/8"
GMA15009	9#	3-5/8"	2-7/16"	GMA15049	49#	2"	1"	GMA15089	I	4-1/8"	2-7/8"
GMA15010	10#	3-5/8"	2-7/16"	GMA15050	50#	2"	1"	GMA15090	J	4-1/8"	2-7/8"
GMA15011	11#	3-1/2"	2-5/16"	GMA15051	51#	2"	1"	GMA15091	K	4-1/4"	2-15/16"
GMA15012	12#	3-1/2"	2-5/16"	GMA15052	52#	1-7/8"	7/8"	GMA15092	L	4-1/4"	2-15/16"
GMA15013	13#	3-1/2"	2-5/16"	GMA15053	53#	1-7/8"	7/8"	GMA15093	M	4-3/8"	3-1/16"
GMA15014	14#	3-3/8"	2-3/16"	GMA15054	54#	1-7/8"	7/8"	GMA15094	N	4-3/8"	3-1/16"
GMA15015	15#	3-3/8"	2-3/16"	GMA15055	55#	1-7/8"	7/8"	GMA15095	O	4-1/2"	3-3/16"
GMA15016	16#	3-3/8"	2-3/16"	GMA15056	56#	1-3/4"	3/4"	GMA15096	P	4-5/8"	3-5/16"
GMA15017	17#	3-3/8"	2-3/16"	GMA15057	57#	1-3/4"	3/4"	GMA15097	Q	4-3/4"	3-7/16"
GMA15018	18#	3-1/4"	2-1/8"	GMA15058	58#	1-5/8"	11/16"	GMA15098	R	4-3/4"	3-7/16"
GMA15019	19#	3-1/4"	2-1/8"	GMA15059	59#	1-5/8"	11/16"	GMA15099	S	4-7/8"	3-1/2"
GMA15020	20#	3-1/4"	2-1/8"	GMA15060	60#	1-5/8"	11/16"	GMA15100	T	4-7/8"	3-1/2"
GMA15021	21#	3-1/4"	2-1/8"	GMA15061	61#	1-5/8"	11/16"	GMA15101	U	5"	3-5/8"
GMA15022	22#	3-1/8"	2"	GMA15062	62#	1-1/2"	5/8"	GMA15102	V	5"	3-5/8"
GMA15023	23#	3-1/8"	2"	GMA15063	63#	1-1/2"	5/8"	GMA15103	W	5-1/8"	3-3/4"
GMA15024	24#	3-1/8"	2"	GMA15064	64#	1-1/2"	5/8"	GMA15104	X	5-1/8"	3-3/4"
GMA15025	25#	3"	1-7/8"	GMA15065	65#	1-1/2"	5/8"	GMA15105	Y	5-1/4"	3-7/8"
GMA15026	26#	3"	1-7/8"	GMA15066	66#	1-3/8"	1/2"	GMA15106	Z	5-1/4"	3-7/8"
GMA15027	27#	3"	1-7/8"	GMA15067	67#	1-3/8"	1/2"				
GMA15028	28#	2-7/8"	1-3/4"	GMA15068	68#	1-3/8"	1/2"				
GMA15029	29#	2-7/8"	1-3/4"	GMA15069	69#	1-3/8"	1/2"				
GMA15030	30#	2-3/4"	1-5/8"	GMA15070	70#	1-1/4"	3/8"				
GMA15031	31#	2-3/4"	1-5/8"	GMA15071	71#	1-1/4"	3/8"				
GMA15032	32#	2-3/4"	1-5/8"	GMA15072	72#	1-1/8"	5/16"				
GMA15033	33#	2-5/8"	1-1/2"	GMA15073	73#	1-1/8"	5/16"				
GMA15034	34#	2-5/8"	1-1/2"	GMA15074	74#	1"	1/4"				
GMA15035	35#	2-5/8"	1-1/2"	GMA15075	75#	1"	1/4"				
GMA15036	36#	2-1/2"	1-7/16"	GMA15076	76#	7/8"	3/16"				
GMA15037	37#	2-1/2"	1-7/16"	GMA15077	77#	7/8"	3/16"				
GMA15038	38#	2-1/2"	1-7/16"	GMA15078	78#	7/8"	3/16"				
GMA15039	39#	2-3/8"	1-3/8"	GMA15079	79#	3/4"	1/8"				
GMA15040	40#	2-3/8"	1-3/8"	GMA15080	80#	3/4"	1/8"				



HSS Straight Shank Twist Drill-JIS

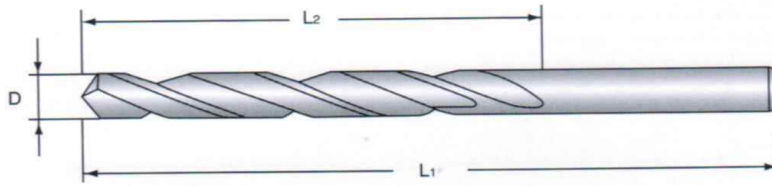

mm

Art No.	D	L1	L2	Art No.	D	L1	L2	Art No.	D	L1	L2
GMA16001	0.5	22	6	GMA16048	3.7	76	48	GMA16095	8.4	121	87
GMA16002	0.55	24	7	GMA16049	3.8	76	48	GMA16096	8.5	121	87
GMA16003	0.6	24	7	GMA16050	3.9	79	51	GMA16097	8.6	121	87
GMA16004	0.65	26	8	GMA16051	4	83	54	GMA16098	8.7	121	87
GMA16005	0.7	28	9	GMA16052	4.1	83	54	GMA16099	8.8	124	89
GMA16006	0.75	28	9	GMA16053	4.2	83	54	GMA16100	8.9	124	89
GMA16007	0.8	30	10	GMA16054	4.3	83	54	GMA16101	9	124	89
GMA16008	0.85	30	10	GMA16055	4.4	86	56	GMA16102	9.1	124	89
GMA16009	0.9	32	11	GMA16056	4.5	86	56	GMA16103	9.2	127	92
GMA16010	0.95	32	11	GMA16057	4.6	86	56	GMA16104	9.3	127	92
GMA16011	1	34	12	GMA16058	4.7	89	59	GMA16105	9.4	127	92
GMA16012	1.05	34	12	GMA16059	4.8	89	59	GMA16106	9.5	127	92
GMA16013	1.1	36	14	GMA16060	4.9	92	62	GMA16107	9.6	130	95
GMA16014	1.15	36	14	GMA16061	5	92	62	GMA16108	9.7	130	95
GMA16015	1.2	38	16	GMA16062	5.1	92	62	GMA16109	9.8	130	95
GMA16016	1.25	38	16	GMA16063	5.2	95	64	GMA16110	9.9	130	95
GMA16017	1.3	38	16	GMA16064	5.3	95	64	GMA16111	10	130	95
GMA16018	1.35	40	18	GMA16065	5.4	95	64	GMA16112	10.1	133	98
GMA16019	1.4	40	18	GMA16066	5.5	95	64	GMA16113	10.2	133	98
GMA16020	1.45	40	18	GMA16067	5.6	98	67	GMA16114	10.3	133	98
GMA16021	1.5	40	18	GMA16068	5.7	98	67	GMA16115	10.4	133	98
GMA16022	1.55	43	20	GMA16069	5.8	98	67	GMA16116	10.5	137	100
GMA16023	1.6	43	20	GMA16070	5.9	98	67	GMA16117	10.6	137	100
GMA16024	1.65	43	20	GMA16071	6	102	70	GMA16118	10.7	137	100
GMA16025	1.7	43	20	GMA16072	6.1	102	70	GMA16119	10.8	140	103
GMA16026	1.75	46	22	GMA16073	6.2	102	70	GMA16120	10.9	140	103
GMA16027	1.8	46	22	GMA16074	6.3	102	70	GMA16121	11	140	103
GMA16028	1.85	46	22	GMA16075	6.4	105	73	GMA16122	11.1	140	103
GMA16029	1.9	46	22	GMA16076	6.5	105	73	GMA16123	11.2	143	106
GMA16030	1.95	49	24	GMA16077	6.6	105	73	GMA16124	11.3	143	106
GMA16031	2	55	29	GMA16078	6.7	105	73	GMA16125	11.4	143	106
GMA16032	2.1	55	29	GMA16079	6.8	105	73	GMA16126	11.5	143	106
GMA16033	2.2	58	33	GMA16080	6.9	105	73	GMA16127	11.6	146	109
GMA16034	2.3	58	33	GMA16081	7	105	73	GMA16128	11.7	146	109
GMA16035	2.4	61	35	GMA16082	7.1	108	75	GMA16129	11.8	146	109
GMA16036	2.5	61	35	GMA16083	7.2	108	75	GMA16130	11.9	146	109
GMA16037	2.6	64	37	GMA16084	7.3	108	75	GMA16131	12	149	111
GMA16038	2.7	64	37	GMA16085	7.4	111	78	GMA16132	12.1	149	111
GMA16039	2.8	67	39	GMA16086	7.5	111	78	GMA16133	12.2	149	111
GMA16040	2.9	71	42	GMA16087	7.6	111	78	GMA16134	12.3	149	111
GMA16041	3	71	42	GMA16088	7.7	114	81	GMA16135	12.4	152	114
GMA16042	3.1	71	42	GMA16089	7.8	114	81	GMA16136	12.5	152	114
GMA16043	3.2	71	42	GMA16090	7.9	114	81	GMA16137	12.6	152	114
GMA16044	3.3	73	45	GMA16091	8	114	81	GMA16138	12.7	152	114
GMA16045	3.4	73	45	GMA16092	8.1	117	84	GMA16139	12.8	152	114
GMA16046	3.5	73	45	GMA16093	8.2	117	84	GMA16140	12.9	152	114
GMA16047	3.6	76	48	GMA16094	8.3	117	84	GMA16141	13	152	114



HSS Straight Shank Twist Drill--Aircraft Extension

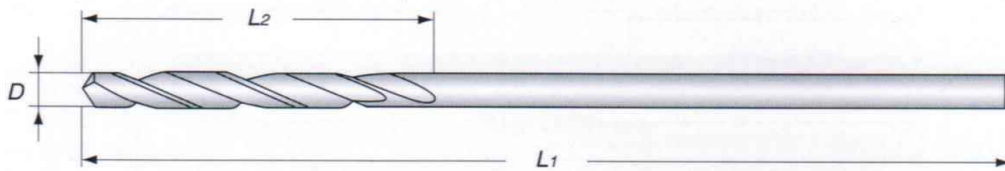

Art No.	D	L1	L2	Art No.	D	L1	L2
GMA17001	1/16"	6"	7/8"	GMA17030	1/16"	12"	7/8"
GMA17002	5/64"	6"	1"	GMA17031	5/64"	12"	1"
GMA17003	3/32"	6"	1-1/4"	GMA17032	3/32"	12"	1-1/4"
GMA17004	7/64"	6"	1-1/2"	GMA17033	7/64"	12"	1-1/2"
GMA17005	1/8"	6"	1-5/8"	GMA17034	1/8"	12"	1-5/8"
GMA17006	9/64"	6"	1-3/4"	GMA17035	9/64"	12"	1-3/4"
GMA17007	5/32"	6"	2"	GMA17036	5/32"	12"	2"
GMA17008	11/64"	6"	2-1/8"	GMA17037	11/64"	12"	2-1/8"
GMA17009	3/16"	6"	2-5/16"	GMA17038	3/16"	12"	2-5/16"
GMA17010	13/64"	6"	2-7/16"	GMA17039	13/64"	12"	2-7/16"
GMA17011	7/32"	6"	2-1/2"	GMA17040	7/32"	12"	2-1/2"
GMA17012	15/64"	6"	2-5/8"	GMA17041	15/64"	12"	2-5/8"
GMA17013	1/4"	6"	2-3/4"	GMA17042	1/4"	12"	2-3/4"
GMA17014	17/64"	6"	2-7/8"	GMA17043	17/64"	12"	2-7/8"
GMA17015	9/32"	6"	2-15/16"	GMA17044	9/32"	12"	2-15/16"
GMA17016	19/64"	6"	3-1/16"	GMA17045	19/64"	12"	3-1/16"
GMA17017	5/16"	6"	3-3/16"	GMA17046	5/16"	12"	3-3/16"
GMA17018	21/64"	6"	3-5/16"	GMA17047	21/64"	12"	3-5/16"
GMA17019	11/32"	6"	3-7/16"	GMA17048	11/32"	12"	3-7/16"
GMA17020	23/64"	6"	3-1/2"	GMA17049	23/64"	12"	3-1/2"
GMA17021	3/8"	6"	3-5/8"	GMA17050	3/8"	12"	3-5/8"
GMA17022	25/64"	6"	3-3/4"	GMA17051	25/64"	12"	3-3/4"
GMA17023	13/32"	6"	3-7/8"	GMA17052	13/32"	12"	3-7/8"
GMA17024	27/64"	6"	3-15/16"	GMA17053	27/64"	12"	3-15/16"
GMA17025	7/16"	6"	4-1/16"	GMA17054	7/16"	12"	4-1/16"
GMA17026	29/64"	6"	4-3/16"	GMA17055	29/64"	12"	4-3/16"
GMA17027	15/32"	6"	4-5/16"	GMA17056	15/32"	12"	4-5/16"
GMA17028	31/64"	6"	4-3/8"	GMA17057	31/64"	12"	4-3/8"
GMA17029	1/2"	6"	4-1/2"	GMA17058	1/2"	12"	4-1/2"



HSS Straight Shank Twist Drill--Extra Length

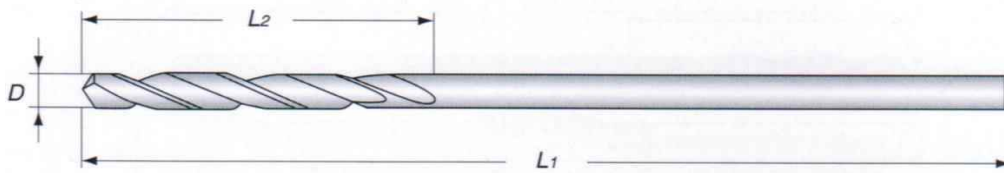

Art No.	D	L1	L2	Art No.	D	L1	L2	Art No.	D	L1	L2
GMA18001	1/8"	8"	6"	GMA18026	1/8"	12"	9"	GMA18051	1/4"	18"	12"
GMA18002	9/64"	8"	6"	GMA18027	9/64"	12"	9"	GMA18052	17/64"	18"	12"
GMA18003	5/32"	8"	6"	GMA18028	5/32"	12"	9"	GMA18053	9/32"	18"	12"
GMA18004	11/64"	8"	6"	GMA18029	11/64"	12"	9"	GMA18054	19/64"	18"	12"
GMA18005	3/16"	8"	6"	GMA18030	3/16"	12"	9"	GMA18055	5/16"	18"	12"
GMA18006	13/64"	8"	6"	GMA18031	13/64"	12"	9"	GMA18056	21/64"	18"	12"
GMA18007	7/32"	8"	6"	GMA18032	7/32"	12"	9"	GMA18057	11/32"	18"	12"
GMA18008	15/64"	8"	6"	GMA18033	15/64"	12"	9"	GMA18058	23/64"	18"	12"
GMA18009	1/4"	8"	6"	GMA18034	1/4"	12"	9"	GMA18059	3/8"	18"	12"
GMA18010	17/64"	8"	6"	GMA18035	17/64"	12"	9"	GMA18060	25/64"	18"	12"
GMA18011	9/32"	8"	6"	GMA18036	9/32"	12"	9"	GMA18061	13/32"	18"	12"
GMA18012	16/64"	8"	6"	GMA18037	19/64"	12"	9"	GMA18062	27/64"	18"	12"
GMA18013	5/16"	8"	6"	GMA18038	5/16"	12"	9"	GMA18063	7/16"	18"	12"
GMA18014	21/64"	8"	6"	GMA18039	21/64"	12"	9"	GMA18064	29/64"	18"	12"
GMA18015	11/32"	8"	6"	GMA18040	11/32"	12"	9"	GMA18065	15/32"	18"	12"
GMA18016	23/64"	8"	6"	GMA18041	23/64"	12"	9"	GMA18066	31/64"	18"	12"
GMA18017	3/8"	8"	6"	GMA18042	3/8"	12"	9"	GMA18067	1/2"	18"	12"
GMA18018	25/64"	8"	6"	GMA18043	25/64"	12"	9"	GMA18068	33/64"	18"	12"
GMA18019	13/32"	8"	6"	GMA18044	13/32"	12"	9"	GMA18069	17/32"	18"	12"
GMA18020	27/64"	8"	6"	GMA18045	27/64"	12"	9"	GMA18070	35/64"	18"	12"
GMA18021	7/16"	8"	6"	GMA18046	7/16"	12"	9"	GMA18071	9/16"	18"	12"
GMA18022	29/64"	8"	6"	GMA18047	29/64"	12"	9"	GMA18072	37/64"	18"	12"
GMA18023	15/32"	8"	6"	GMA18048	15/32"	12"	9"	GMA18073	19/32"	18"	12"
GMA18024	31/64"	8"	6"	GMA18049	31/64"	12"	9"	GMA18074	39/64"	18"	12"
GMA18025	1/2"	8"	6"	GMA18050	1/2"	12"	9"	GMA18075	5/8"	18"	12"
								GMA18076	41/64"	18"	12"
								GMA18077	21/32"	18"	12"
								GMA18078	43/64"	18"	12"
								GMA18079	11/16"	18"	12"
								GMA18080	45/64"	18"	12"
								GMA18081	23/32"	18"	12"
								GMA18082	47/64"	18"	12"
								GMA18083	3/4"	18"	12"



HSS Taper Shank Twist Drill DIN345

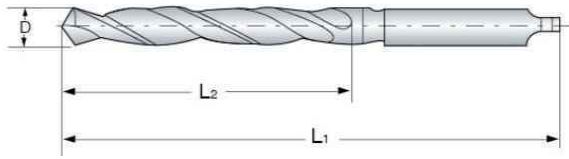

mm														
Art No.	D	L1	L2	shank	Art No.	D	L1	L2	shank	Art No.	D	L1	L2	shank
GMA19001	5.00	133	52	1#	GMA19053	24.50	281	160	3#	GMA19105	50.00	369	220	4#
GMA19002	5.20	133	52	1#	GMA19054	25.00	281	160	3#	GMA19106	50.50	374	225	4#
GMA19003	5.50	138	57	1#	GMA19055	25.50	286	165	3#	GMA19107	51.00	412	225	5#
GMA19004	6.00	138	57	1#	GMA19056	26.00	286	165	3#	GMA19108	52.00	412	225	5#
GMA19005	6.20	144	63	1#	GMA19057	26.50	286	165	3#	GMA19109	53.00	412	225	5#
GMA19006	6.50	144	63	1#	GMA19058	27.00	291	170	3#	GMA19110	54.00	417	230	5#
GMA19007	6.80	150	69	1#	GMA19059	27.50	291	170	3#	GMA19111	55.00	417	230	5#
GMA19008	7.00	150	69	1#	GMA19060	28.00	291	170	3#	GMA19112	56.00	417	230	5#
GMA19009	7.50	150	69	1#	GMA19061	28.50	296	175	3#	GMA19113	57.00	422	235	5#
GMA19010	7.80	156	75	1#	GMA19062	29.00	296	175	3#	GMA19114	58.00	422	235	5#
GMA19011	8.00	156	75	1#	GMA19063	29.50	296	175	3#	GMA19115	59.00	422	235	5#
GMA19012	8.50	156	75	1#	GMA19064	30.00	296	175	3#	GMA19116	60.00	422	235	5#
GMA19013	8.80	162	81	1#	GMA19065	30.50	301	180	3#	GMA19117	61.00	427	240	5#
GMA19014	9.00	162	81	1#	GMA19066	31.00	301	180	3#	GMA19118	62.00	427	240	5#
GMA19015	9.50	162	81	1#	GMA19067	31.50	301	180	3#	GMA19119	63.00	427	240	5#
GMA19016	9.80	168	87	1#	GMA19068	31.75	306	185	3#	GMA19120	64.00	432	245	5#
GMA19017	10.00	168	87	1#	GMA19069	32.00	334	185	4#	GMA19121	65.00	432	245	5#
GMA19018	10.50	168	87	1#	GMA19070	32.50	334	185	4#	GMA19122	66.00	432	245	5#
GMA19019	10.80	175	94	1#	GMA19071	33.00	334	185	4#	GMA19123	67.00	432	245	5#
GMA19020	11.00	175	94	1#	GMA19072	33.50	334	185	4#	GMA19124	68.00	437	250	5#
GMA19021	11.50	175	94	1#	GMA19073	34.00	339	190	4#	GMA19125	69.00	437	250	5#
GMA19022	11.80	175	94	1#	GMA19074	34.50	339	190	4#	GMA19126	70.00	437	250	5#
GMA19023	12.00	182	101	1#	GMA19075	35.00	339	190	4#	GMA19127	71.00	437	250	5#
GMA19024	12.50	182	101	1#	GMA19076	35.50	339	190	4#	GMA19128	72.00	442	255	5#
GMA19025	13.00	182	101	1#	GMA19077	36.00	344	195	4#	GMA19129	73.00	442	255	5#
GMA19026	13.20	182	101	1#	GMA19078	36.50	344	195	4#	GMA19130	74.00	442	255	5#
GMA19027	13.50	189	108	1#	GMA19079	37.00	344	195	4#	GMA19131	75.00	442	255	5#
GMA19028	14.00	189	108	1#	GMA19080	37.50	344	195	4#	GMA19132	76.00	447	260	5#
GMA19029	14.25	212	114	2#	GMA19081	38.00	349	200	4#	GMA19133	77.00	514	260	6#
GMA19030	14.50	212	114	2#	GMA19082	38.50	349	200	4#	GMA19134	78.00	514	260	6#
GMA19031	15.00	212	114	2#	GMA19083	39.00	349	200	4#	GMA19135	79.00	514	260	6#
GMA19032	15.25	218	120	2#	GMA19084	39.50	349	200	4#	GMA19136	80.00	514	260	6#
GMA19033	15.50	218	120	2#	GMA19085	40.00	349	200	4#	GMA19137	81.00	519	265	6#
GMA19034	16.00	218	120	2#	GMA19086	40.50	354	205	4#	GMA19138	82.00	519	265	6#
GMA19035	16.25	223	125	2#	GMA19087	41.00	354	205	4#	GMA19139	83.00	519	265	6#
GMA19036	16.50	223	125	2#	GMA19088	41.50	354	205	4#	GMA19140	84.00	519	265	6#
GMA19037	17.00	223	125	2#	GMA19089	42.00	354	205	4#	GMA19141	85.00	519	265	6#
GMA19038	17.25	228	130	2#	GMA19090	42.50	354	205	4#	GMA19142	86.00	524	270	6#
GMA19039	17.50	228	130	2#	GMA19091	43.00	359	210	4#	GMA19143	87.00	524	270	6#
GMA19040	18.00	228	130	2#	GMA19092	43.50	359	210	4#	GMA19144	88.00	524	270	6#
GMA19041	18.50	233	135	2#	GMA19093	44.00	359	210	4#	GMA19145	89.00	524	270	6#
GMA19042	19.00	233	135	2#	GMA19094	44.50	359	210	4#	GMA19146	90.00	524	270	6#
GMA19043	19.50	238	140	2#	GMA19095	45.00	359	210	4#	GMA19147	91.00	529	275	6#
GMA19044	20.00	238	140	2#	GMA19096	45.50	364	215	4#	GMA19148	92.00	529	275	6#
GMA19045	20.50	243	145	2#	GMA19097	46.00	364	215	4#	GMA19149	93.00	529	275	6#
GMA19046	21.00	243	145	2#	GMA19098	46.50	364	215	4#	GMA19150	94.00	529	275	6#
GMA19047	21.50	248	150	2#	GMA19099	47.00	364	215	4#	GMA19151	95.00	529	275	6#
GMA19048	22.00	248	150	2#	GMA19100	47.50	364	215	4#	GMA19152	96.00	534	280	6#
GMA19049	22.50	253	155	2#	GMA19101	48.00	369	220	4#	GMA19153	97.00	534	280	6#
GMA19050	23.00	253	155	2#	GMA19102	48.50	369	220	4#	GMA19154	98.00	534	280	6#
GMA19051	23.50	276	155	3#	GMA19103	49.00	369	220	4#	GMA19155	99.00	534	280	6#
GMA19052	24.00	281	160	3#	GMA19104	49.50	369	220	4#	GMA19156	100.00	534	280	6#



HSS Taper Shank Twist Drill--ANSI STANDARD

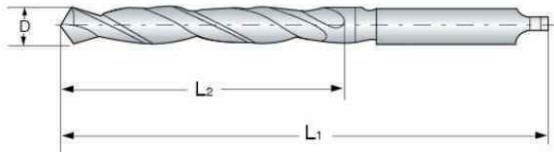

Art No.	D	L1	L2	shank	Art No.	D	L1	L2	shank	Art No.	D	L1	L2	shank
GMA20001	1/8"	5-1/8"	1-7/8"	1#	GMA20057	1"	11"	6-3/8"	3#	GMA20113	1-7/8"	17-3/8"	10-3/8"	5#
GMA20002	9/64"	5-3/8"	2-1/8"	1#	GMA20058	1-1/16"	11-1/8"	6-1/2"	3#	GMA20114	1-57/64"	17-3/8"	10-3/8"	5#
GMA20003	5/32"	5-3/8"	2-1/8"	1#	GMA20059	1-1/32"	11-1/8"	6-1/2"	3#	GMA20115	1-29/32"	17-3/8"	10-3/8"	5#
GMA20004	11/64"	5-3/4"	2-1/2"	1#	GMA20060	1-3/64"	11-1/4"	6-5/8"	3#	GMA20116	1-59/64"	17-3/8"	10-3/8"	5#
GMA20005	3/16"	5-3/4"	2-1/2"	1#	GMA20061	1-1/16"	11-1/4"	6-5/8"	3#	GMA20117	1-15/16"	17-3/8"	10-3/8"	5#
GMA20006	13/64"	6"	2-3/4"	1#	GMA20062	1-5/64"	12-1/2"	6-7/8"	4#	GMA20118	1-61/64"	17-3/8"	10-3/8"	5#
GMA20007	7/32"	6"	2-3/4"	1#	GMA20063	1-3/32"	12-1/2"	6-7/8"	4#	GMA20119	1-31/32"	17-3/8"	10-3/8"	5#
GMA20008	15/64"	6-1/8"	2-7/8"	1#	GMA20064	1-7/64"	12-3/4"	7-1/8"	4#	GMA20120	1-63/64"	17-3/8"	10-3/8"	5#
GMA20009	1/4"	6-1/8"	2-7/8"	1#	GMA20065	1-1/8"	12-3/4"	7-1/8"	4#	GMA20121	2"	17-3/8"	10-3/8"	5#
GMA20010	17/64"	6-1/4"	3"	1#	GMA20066	1-9/64"	12-7/8"	7-1/4"	4#	GMA20122	2-1/64"	17-3/8"	10-3/8"	5#
GMA20011	9/32"	6-1/4"	3"	1#	GMA20067	1-5/32"	12-7/8"	7-1/4"	4#	GMA20123	2-1/32"	17-3/8"	10-3/8"	5#
GMA20012	19/64"	6-3/8"	3-1/8"	1#	GMA20068	1-11/64"	13"	7-3/8"	4#	GMA20124	2-3/64"	17-3/8"	10-1/4"	5#
GMA20013	5/16"	6-3/8"	3-1/8"	1#	GMA20069	1-3/16"	13"	7-3/8"	4#	GMA20125	2-1/16"	17-3/8"	10-1/4"	5#
GMA20014	21/64"	6-1/2"	3-1/4"	1#	GMA20070	1-13/64"	13-1/8"	7-1/2"	4#	GMA20126	2-3/32"	17-3/8"	10-1/4"	5#
GMA20015	11/32"	6-1/2"	3-1/4"	1#	GMA20071	1-7/32"	13-1/8"	7-1/2"	4#	GMA20127	2-1/8"	17-3/8"	10-1/4"	5#
GMA20016	23/64"	6-3/4"	3-1/2"	1#	GMA20072	1-15/64"	13-1/2"	7-7/8"	4#	GMA20128	2-5/32"	17-3/8"	10-1/4"	5#
GMA20017	3/8"	6-3/4"	3-1/2"	1#	GMA20073	1-1/4"	13-1/2"	7-7/8"	4#	GMA20129	2-3/16"	17-3/8"	10-1/4"	5#
GMA20018	25/64"	7"	3-5/8"	1#	GMA20074	1-17/64"	14-1/8"	8-1/2"	4#	GMA20130	2-7/32"	17-3/8"	10-1/8"	5#
GMA20019	13/32"	7"	3-5/8"	1#	GMA20075	1-9/32"	14-1/8"	8-1/2"	4#	GMA20131	2-1/4"	17-3/8"	10-1/8"	5#
GMA20020	27/64"	7-1/4"	3-7/8"	1#	GMA20076	1-19/64"	14-1/4"	8-5/8"	4#	GMA20132	2-9/32"	17-3/8"	10-1/8"	5#
GMA20021	7/16"	7-1/4"	3-7/8"	1#	GMA20077	1-5/16"	14-1/4"	8-5/8"	4#	GMA20133	2-5/16"	17-3/8"	10-1/8"	5#
GMA20022	29/64"	7-1/2"	4-1/8"	1#	GMA20078	1-21/64"	14-3/8"	8-3/4"	4#	GMA20134	2-11/32"	17-3/8"	10-1/8"	5#
GMA20023	15/32"	7-1/2"	4-1/8"	1#	GMA20079	1-11/32"	14-3/8"	8-3/4"	4#	GMA20135	2-3/8"	17-3/8"	10-1/8"	5#
GMA20024	31/64"	8-1/4"	4-3/8"	2#	GMA20080	1-23/64"	14-1/2"	8-7/8"	4#	GMA20136	2-13/32"	18-3/4"	11-1/4"	5#
GMA20025	1/2"	8-1/4"	4-3/8"	2#	GMA20081	1-3/8"	14-1/2"	8-7/8"	4#	GMA20137	2-7/16"	18-3/4"	11-1/4"	5#
GMA20026	33/64"	8-1/2"	4-5/8"	2#	GMA20082	1-25/64"	14-5/8"	9"	4#	GMA20138	2-15/32"	18-3/4"	11-1/4"	5#
GMA20027	17/32"	8-1/2"	4-5/8"	2#	GMA20083	1-13/32"	14-5/8"	9"	4#	GMA20139	2-1/2"	18-3/4"	11-1/4"	5#
GMA20028	35/64"	8-3/4"	4-7/8"	2#	GMA20084	1-27/64"	14-3/4"	9-1/8"	4#	GMA20140	2-17/32"	19-1/2"	11-7/8"	5#
GMA20029	9/16"	8-3/4"	4-7/8"	2#	GMA20085	1-7/16"	14-3/4"	9-1/8"	4#	GMA20141	2-9/16"	19-1/2"	11-7/8"	5#
GMA20030	37/64"	8-3/4"	4-7/8"	2#	GMA20086	1-29/64"	14-7/8"	9-1/4"	4#	GMA20142	2-19/32"	19-1/2"	11-7/8"	5#
GMA20031	19/32"	8-3/4"	4-7/8"	2#	GMA20087	1-15/32"	14-7/8"	9-1/4"	4#	GMA20143	2-5/8"	19-1/2"	11-7/8"	5#
GMA20032	39/64"	8-3/4"	4-7/8"	2#	GMA20088	1-31/64"	15"	9-3/8"	4#	GMA20144	2-21/32"	20-3/8"	12-3/4"	5#
GMA20033	5/8"	8-3/4"	4-7/8"	2#	GMA20089	1-1/2"	15"	9-3/8"	4#	GMA20145	2-11/16"	20-3/8"	12-3/4"	5#
GMA20034	41/64"	9"	5-1/8"	2#	GMA20090	1-33/64"	16-3/8"	9-3/8"	5#	GMA20146	2-23/32"	20-3/8"	12-3/4"	5#
GMA20035	21/32"	9"	5-1/8"	2#	GMA20091	1-17/32"	16-3/8"	9-3/8"	5#	GMA20147	2-3/4"	20-3/8"	12-3/4"	5#
GMA20036	43/64"	9-1/4"	5-3/8"	2#	GMA20092	1-35/64"	16-5/8"	9-5/8"	5#	GMA20148	2-25/32"	21-1/8"	13-3/8"	5#
GMA20037	11/16"	9-1/4"	5-3/8"	2#	GMA20093	1-9/16"	16-5/8"	9-5/8"	5#	GMA20149	2-13/16"	21-1/8"	13-3/8"	5#
GMA20038	45/64"	9-1/2"	5-5/8"	2#	GMA20094	1-37/64"	16-7/8"	9-7/8"	5#	GMA20150	2-27/32"	21-1/8"	13-3/8"	5#
GMA20039	23/32"	9-1/2"	5-5/8"	2#	GMA20095	1-19/32"	16-7/8"	9-7/8"	5#	GMA20151	2-7/8"	21-1/8"	13-3/8"	5#
GMA20040	47/64"	9-3/4"	5-7/8"	2#	GMA20096	1-39/64"	17"	10"	5#	GMA20152	2-29/32"	21-1/8"	13-3/8"	5#
GMA20041	3/4"	9-3/4"	5-7/8"	2#	GMA20097	1-5/8"	17"	10"	5#	GMA20153	2-15/16"	21-3/4"	14"	5#
GMA20042	49/64"	9-7/8"	6"	2#	GMA20098	1-41/64"	17-1/8"	10-1/8"	5#	GMA20154	2-31/32"	21-3/4"	14"	5#
GMA20043	25/32"	9-7/8"	6"	2#	GMA20099	1-21/32"	17-1/8"	10-1/8"	5#	GMA20155	3"	21-3/4"	14"	5#
GMA20044	51/64"	10-3/4"	6-1/8"	3#	GMA20100	1-43/64"	17-1/8"	10-1/8"	5#	GMA20156	3-1/16"	24-1/2"	14-5/8"	6#
GMA20045	13/16"	10-3/4"	6-1/8"	3#	GMA20101	1-11/16"	17-1/8"	10-1/8"	5#	GMA20157	3-1/8"	24-1/2"	14-5/8"	6#
GMA20046	53/64"	10-3/4"	6-1/8"	3#	GMA20102	1-45/64"	17-1/8"	10-1/8"	5#	GMA20158	3-3/16"	24-1/2"	14-5/8"	6#
GMA20047	27/32"	10-3/4"	6-1/8"	3#	GMA20103	1-23/32"	17-1/8"	10-1/8"	5#	GMA20159	3-1/4"	25-1/2"	15-1/2"	6#
GMA20048	55/64"	10-3/4"	6-1/8"	3#	GMA20104	1-47/64"	17-1/8"	10-1/8"	5#	GMA20160	3-5/16"	25-1/2"	15-1/2"	6#
GMA20049	7/8"	10-3/4"	6-1/8"	3#	GMA20105	1-3/4"	17-1/8"	10-1/8"	5#	GMA20161	3-3/8"	25-1/2"	15-1/2"	6#
GMA20050	57/64"	10-3/4"	6-1/8"	3#	GMA20106	1-49/64"	17-1/8"	10-1/8"	5#	GMA20162	3-7/16"	25-1/2"	15-1/2"	6#
GMA20051	29/32"	10-3/4"	6-1/8"	3#	GMA20107	1-25/32"	17-1/8"	10-1/8"	5#	GMA20163	3-1/2"	26-1/2"	16-3/8"	6#
GMA20052	59/64"	10-3/4"	6-1/8"	3#	GMA20108	1-51/64"	17-1/8"	10-1/8"	5#	GMA20164	3-5/8"	26-1/2"	16-3/8"	6#
GMA20053	15/16"	10-3/4"	6-1/8"	3#	GMA20109	1-13/16"	17-1/8"	10-1/8"	5#	GMA20165	3-3/4"	26-1/2"	16-3/8"	6#
GMA20054	61/64"	11"	6-3/8"	3#	GMA20110	1-53/64"	17-1/8"	10-1/8"	5#	GMA20166	3-7/8"	26-1/2"	16-3/8"	6#
GMA20055	31/32"	11"	6-3/8"	3#	GMA20111	1-27/32"	17-1/8"	10-1/8"	5#	GMA20167	4"	27-1/2"	17-1/2"	6#
GMA20056	63/64"	11"	6-3/8"	3#	GMA20112	1-55/64"	17-3/8"	10-3/8"	5#					



Art No.	D	L1	L2	D	Art No.	D	L1	L2	D
GMA21001	10.00	152	76	9.5	GMA21032	13.00	152	76	12.7
GMA21002	10.50	152	76	9.5	GMA21033	13.50	152	76	12.7
GMA21003	11.00	152	76	9.5	GMA21034	14.00	152	76	12.7
GMA21004	11.50	152	76	9.5	GMA21035	14.50	152	76	12.7
GMA21005	12.00	152	76	9.5	GMA21036	15.00	152	76	12.7
GMA21006	12.50	152	76	9.5	GMA21037	15.50	152	76	12.7
GMA21007	13.00	152	76	9.5	GMA21038	16.00	152	76	12.7
GMA21008	13.50	152	76	9.5	GMA21039	16.50	152	76	12.7
GMA21009	14.00	152	76	9.5	GMA21040	17.00	152	76	12.7
GMA21010	14.50	152	76	9.5	GMA21041	17.50	152	76	12.7
GMA21011	15.00	152	76	9.5	GMA21042	18.00	152	76	12.7
GMA21012	15.50	152	76	9.5	GMA21043	18.50	152	76	12.7
GMA21013	16.00	152	76	9.5	GMA21044	19.00	152	76	12.7
GMA21014	16.50	152	76	9.5	GMA21045	19.50	152	76	12.7
GMA21015	17.00	152	76	9.5	GMA21046	20.00	152	76	12.7
GMA21016	17.50	152	76	9.5	GMA21047	20.50	152	76	12.7
GMA21017	18.00	152	76	9.5	GMA21048	21.00	152	76	12.7
GMA21018	18.50	152	76	9.5	GMA21049	21.50	152	76	12.7
GMA21019	19.00	152	76	9.5	GMA21050	22.00	152	76	12.7
GMA21020	19.50	152	76	9.5	GMA21051	22.50	152	76	12.7
GMA21021	20.00	152	76	9.5	GMA21052	23.00	152	76	12.7
GMA21022	20.50	152	76	9.5	GMA21053	23.50	152	76	12.7
GMA21023	21.00	152	76	9.5	GMA21054	24.00	152	76	12.7
GMA21024	21.50	152	76	9.5	GMA21055	24.50	152	76	12.7
GMA21025	22.00	152	76	9.5	GMA21056	25.00	152	76	12.7
GMA21026	22.50	152	76	9.5	GMA21057	25.50	152	76	12.7
GMA21027	23.00	152	76	9.5	GMA21058	26.00	152	76	12.7
GMA21028	23.50	152	76	9.5	GMA21059	26.50	152	76	12.7
GMA21029	24.00	152	76	9.5	GMA21060	27.00	152	76	12.7
GMA21030	24.50	152	76	9.5	GMA21061	27.50	152	76	12.7
GMA21031	25.00	152	76	9.5	GMA21062	28.00	152	76	12.7
					GMA21063	28.50	152	76	12.7
					GMA21064	29.00	152	76	12.7
					GMA21065	29.50	152	76	12.7
					GMA21066	30.00	152	76	12.7

Art No.	D	L1	L2	D	Art No.	D	L1	L2	D
GMA21067	33/64"	6"	3"	1/2"	GMA21099	1-1/64"	6"	3"	1/2"
GMA21068	17/32"	6"	3"	1/2"	GMA21100	1-1/32"	6"	3"	1/2"
GMA21069	35/64"	6"	3"	1/2"	GMA21101	1-3/64"	6"	3"	1/2"
GMA21070	9/16"	6"	3"	1/2"	GMA21102	1-1/16"	6"	3"	1/2"
GMA21071	37/64"	6"	3"	1/2"	GMA21103	1-5/64"	6"	3"	1/2"
GMA21072	19/32"	6"	3"	1/2"	GMA21104	1-3/32"	6"	3"	1/2"
GMA21073	39/64"	6"	3"	1/2"	GMA21105	1-7/64"	6"	3"	1/2"
GMA21074	5/8"	6"	3"	1/2"	GMA21106	1-1/8"	6"	3"	1/2"
GMA21075	41/64"	6"	3"	1/2"	GMA21107	1-9/64"	6"	3"	1/2"
GMA21076	21/32"	6"	3"	1/2"	GMA21108	1-5/32"	6"	3"	1/2"
GMA21077	43/64"	6"	3"	1/2"	GMA21109	1-11/64"	6"	3"	1/2"
GMA21078	11/16"	6"	3"	1/2"	GMA21110	1-3/16"	6"	3"	1/2"
GMA21079	45/64"	6"	3"	1/2"	GMA21111	1-13/64"	6"	3"	1/2"
GMA21080	23/32"	6"	3"	1/2"	GMA21112	1-7/32"	6"	3"	1/2"
GMA21081	47/64"	6"	3"	1/2"	GMA21113	1-15/64"	6"	3"	1/2"
GMA21082	3/4"	6"	3"	1/2"	GMA21114	1-1/4"	6"	3"	1/2"
GMA21083	49/64"	6"	3"	1/2"	GMA21115	1-17/64"	6"	3"	1/2"
GMA21084	25/32"	6"	3"	1/2"	GMA21116	1-9/32"	6"	3"	1/2"
GMA21085	51/64"	6"	3"	1/2"	GMA21117	1-19/64"	6"	3"	1/2"
GMA21086	13/16"	6"	3"	1/2"	GMA21118	1-5/16"	6"	3"	1/2"
GMA21087	53/64"	6"	3"	1/2"	GMA21119	1-21/64"	6"	3"	1/2"
GMA21088	27/32"	6"	3"	1/2"	GMA21120	1-11/32"	6"	3"	1/2"
GMA21089	55/64"	6"	3"	1/2"	GMA21121	1-23/64"	6"	3"	1/2"
GMA21090	7/8"	6"	3"	1/2"	GMA21122	1-3/8"	6"	3"	1/2"
GMA21091	57/64"	6"	3"	1/2"	GMA21123	1-25/64"	6"	3"	1/2"
GMA21092	29/32"	6"	3"	1/2"	GMA21124	1-13/32"	6"	3"	1/2"
GMA21093	59/64"	6"	3"	1/2"	GMA21125	1-27/64"	6"	3"	1/2"
GMA21094	15/16"	6"	3"	1/2"	GMA21126	1-7/16"	6"	3"	1/2"
GMA21095	61/64"	6"	3"	1/2"	GMA21127	1-29/64"	6"	3"	1/2"
GMA21096	31/32"	6"	3"	1/2"	GMA21128	1-15/32"	6"	3"	1/2"
GMA21097	63/64"	6"	3"	1/2"	GMA21129	1-31/64"	6"	3"	1/2"
GMA21098	1"	6"	3"	1/2"	GMA21130	1-1/2"	6"	3"	1/2"

Art No.	D	L1	L2	D	Art No.	D	L1	L2	D
GMA21131	25/64"	6"	3"	3/8"	GMA21155	1"	6"	3"	3/4"
GMA21132	13/32"	6"	3"	3/8"	GMA21156	1-1/32"	6"	3"	3/4"
GMA21133	27/64"	6"	3"	3/8"	GMA21157	1-1/16"	6"	3"	3/4"
GMA21134	7/16"	6"	3"	3/8"	GMA21158	1-3/32"	6"	3"	3/4"
GMA21135	29/64"	6"	3"	3/8"	GMA21159	1-1/8"	6"	3"	3/4"
GMA21136	15/32"	6"	3"	3/8"	GMA21160	1-5/32"	6"	3"	3/4"
GMA21137	31/64"	6"	3"	3/8"	GMA21161	1-3/16"	6"	3"	3/4"
GMA21138	1/2"	6"	3"	3/8"	GMA21162	1-7/32"	6"	3"	3/4"
GMA21139	33/64"	6"	3"	3/8"	GMA21163	1-1/4"	6"	3"	3/4"
GMA21140	17/32"	6"	3"	3/8"	GMA21164	1-9/32"	6"	3"	3/4"
GMA21141	35/64"	6"	3"	3/8"	GMA21165	1-5/16"	6"	3"	3/4"
GMA21142	9/16"	6"	3"	3/8"	GMA21166	1-11/32"	6"	3"	3/4"
GMA21143	37/64"	6"	3"	3/8"	GMA21167	1-3/8"	6"	3"	3/4"
GMA21144	19/32"	6"	3"	3/8"	GMA21168	1-13/32"	6"	3"	3/4"
GMA21145	39/64"	6"	3"	3/8"	GMA21169	1-7/16"	6"	3"	3/4"
GMA21146	5/8"	6"	3"	3/8"	GMA21170	1-15/32"	6"	3"	3/4"
GMA21147	41/64"	6"	3"	3/8"	GMA21171	1-1/2"	6"	3"	3/4"
GMA21148	21/32"	6"	3"	3/8"	GMA21172	1-17/32"	6"	3"	3/4"
GMA21149	43/64"	6"	3"	3/8"	GMA21173	1-9/16"	6"	3"	3/4"
GMA21150	11/16"	6"	3"	3/8"	GMA21174	1-19/32"	6"	3"	3/4"
GMA21151	45/64"	6"	3"	3/8"	GMA21175	1-5/8"	6"	3"	3/4"
GMA21152	23/32"	6"	3"	3/8"	GMA21176	1-21/32"	6"	3"	3/4"
GMA21153	47/64"	6"	3"	3/8"	GMA21177	1-11/16"	6"	3"	3/4"
GMA21154	3/4"	6"	3"	3/8"	GMA21178	1-23/32"	6"	3"	3/4"
					GMA21179	1-3/4"	6"	3"	3/4"
					GMA21180	1-25/32"	6"	3"	3/4"
					GMA21181	1-13/16"	6"	3"	3/4"
					GMA21182	1-27/32"	6"	3"	3/4"
					GMA21183	1-7/8"	6"	3"	3/4"
					GMA21184	1-29/32"	6"	3"	3/4"
					GMA21185	1-15/16"	6"	3"	3/4"
					GMA21186	1-31/32"	6"	3"	3/4"
					GMA21187	2"	6"	3"	3/4"

HSS Reduced Shank Twist Drill

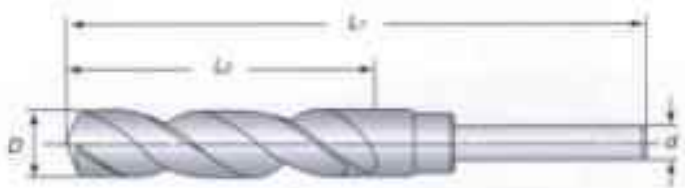



HSS Double End Twist Drill

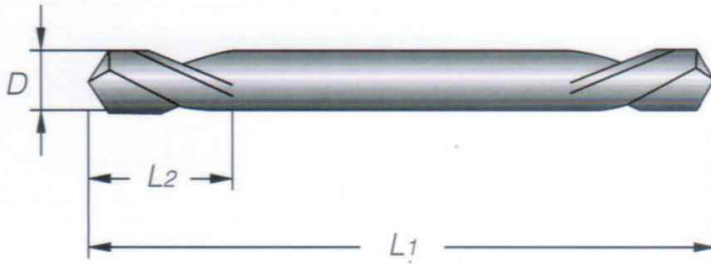

Art No.	D	L1	L2	Art No.	D	L1	L2
GMA22001	2.00	38.0	7.5	GMA22042	6.00	66.0	19.0
GMA22002	2.10	38.0	7.5	GMA22043	6.10	70.0	21.2
GMA22003	2.20	38.0	7.5	GMA22044	6.20	70.0	21.2
GMA22004	2.30	38.0	7.5	GMA22045	6.30	70.0	21.2
GMA22005	2.40	38.0	7.5	GMA22046	6.40	70.0	21.2
GMA22006	2.50	43.0	9.5	GMA22047	6.50	70.0	21.2
GMA22007	2.60	43.0	9.5	GMA22048	6.60	70.0	21.2
GMA22008	2.70	46.0	10.6	GMA22049	6.70	70.0	21.2
GMA22009	2.80	46.0	10.6	GMA22050	6.80	74.0	23.6
GMA22010	2.90	46.0	10.6	GMA22051	6.90	74.0	23.6
GMA22011	3.00	46.0	10.6	GMA22052	7.00	74.0	23.6
GMA22012	3.10	49.0	11.2	GMA22053	7.10	74.0	23.6
GMA22013	3.20	49.0	11.2	GMA22054	7.20	74.0	23.6
GMA22014	3.25	49.0	11.2	GMA22055	7.30	74.0	23.6
GMA22015	3.30	49.0	11.2	GMA22056	7.40	74.0	23.6
GMA22016	3.40	52.0	12.5	GMA22057	7.50	74.0	23.6
GMA22017	3.50	52.0	12.5	GMA22058	7.60	79.0	25.0
GMA22018	3.60	52.0	12.5	GMA22059	7.70	79.0	25.0
GMA22019	3.70	52.0	12.5	GMA22060	7.80	79.0	25.0
GMA22020	3.80	55.0	14.0	GMA22061	7.90	79.0	25.0
GMA22021	3.90	55.0	14.0	GMA22062	8.00	79.0	25.0
GMA22022	4.00	55.0	14.0	GMA22063	8.10	79.0	25.0
GMA22023	4.10	55.0	14.0	GMA22064	8.20	79.0	25.0
GMA22024	4.20	55.0	14.0	GMA22065	8.30	79.0	25.0
GMA22025	4.30	58.0	15.5	GMA22066	8.40	79.0	25.0
GMA22026	4.40	58.0	15.5	GMA22067	8.50	79.0	25.0
GMA22027	4.50	58.0	15.5	GMA22068	8.60	84.0	25.0
GMA22028	4.60	58.0	15.5	GMA22069	8.70	84.0	25.0
GMA22029	4.70	58.0	15.5	GMA22070	8.80	84.0	25.0
GMA22030	4.80	62.0	17.0	GMA22071	8.90	84.0	25.0
GMA22031	4.90	62.0	17.0	GMA22072	9.00	84.0	25.0
GMA22032	5.00	62.0	17.0	GMA22073	9.10	84.0	25.0
GMA22033	5.10	62.0	17.0	GMA22074	9.20	84.0	25.0
GMA22034	5.20	62.0	17.0	GMA22075	9.30	84.0	25.0
GMA22035	5.30	62.0	17.0	GMA22076	9.40	84.0	25.0
GMA22036	5.40	66.0	19.0	GMA22077	9.50	84.0	25.0
GMA22037	5.50	66.0	19.0	GMA22078	9.60	89.0	25.0
GMA22038	5.60	66.0	19.0	GMA22079	9.70	89.0	25.0
GMA22039	5.70	66.0	19.0	GMA22080	9.80	89.0	25.0
GMA22040	5.80	66.0	19.0	GMA22081	9.90	89.0	25.0
GMA22041	5.90	66.0	19.0	GMA22082	10.00	89.0	25.0

Art No.	D	L1	L2
GMA22083	7/64"	1-7/8"	1/2"
GMA22084	1/8"	2"	1/2"
GMA22085	9/64"	2"	1/2"
GMA22086	5/32"	2-1/16"	1/2"
GMA22087	3/16"	2-3/16"	1/2"
GMA22088	7/32"	2-3/8"	1/2"
GMA22089	1/4"	2-1/2"	1/2"
GMA22090	30#	2"	1/2"
GMA22091	20#	2-1/8"	1/2"
GMA22092	11#	2-1/4"	1/2"



HSS Center Drill DIN333

mm

Art No.	Type A			
	d	D	L	l
GMA23001	1.00	3.15	33.50	1.90
GMA23002	1.25	3.15	33.50	1.90
GMA23003	1.60	4.00	37.50	2.80
GMA23004	2.00	5.00	42.00	3.30
GMA23005	2.50	6.30	47.00	4.10
GMA23006	3.15	8.00	52.00	4.90
GMA23007	4.00	10.00	59.00	6.20
GMA23008	5.00	12.50	66.00	7.50
GMA23009	6.30	16.00	74.00	9.20

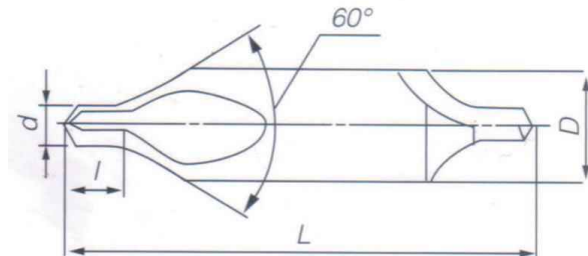

mm

Art No.	Type B			
	d	D	L	l
GMA23011	1.00	4.00	37.50	1.90
GMA23012	1.25	5.00	42.00	2.20
GMA23013	1.60	6.30	47.00	2.80
GMA23014	2.00	8.00	52.50	3.30
GMA23015	2.50	10.00	59.00	4.10
GMA23016	3.15	11.20	63.00	4.90
GMA23017	4.00	14.00	70.00	6.20
GMA23018	5.00	18.00	78.00	7.50
GMA23019	6.30	20.00	83.00	9.20

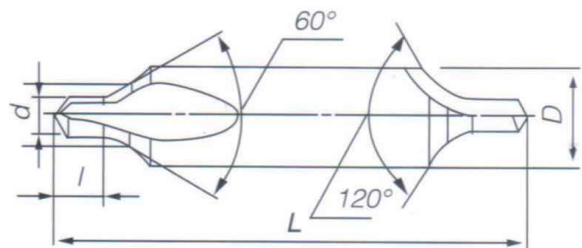

mm

Art No.	Type R			
	d	D	L	l
GMA23020	1.00	3.15	33.50	3.00
GMA23021	1.25	3.15	33.50	3.35
GMA23022	1.60	4.00	37.50	4.25
GMA23023	2.00	5.00	42.00	5.30
GMA23024	2.50	6.30	47.00	6.70
GMA23025	3.15	8.00	52.00	8.50
GMA23026	4.00	10.00	59.00	10.60
GMA23027	5.00	12.50	66.00	13.20
GMA23028	6.30	16.00	74.00	17.00

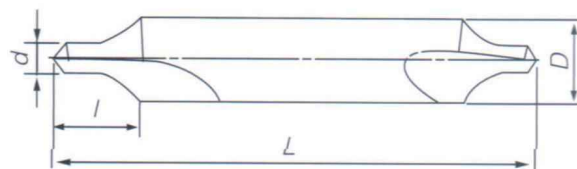



HSS Center Drills--INCH

Art No.	Plain Type			
	Number	D	d	L
GMA24001	000	1/8"	0.02	1-1/4"
GMA24002	00	1/8"	0.025	1-1/4"
GMA24003	0	1/8"	1/32"	1-1/4"
GMA24004	1	1/8"	3/64"	1-1/4"
GMA24005	2	3/16"	5/64"	1-7/8"
GMA24006	3	1/4"	7/64"	2"
GMA24007	4	5/16"	1/8"	2-1/8"
GMA24008	4-1/2	3/8"	9/64"	2-1/2"
GMA24009	5	7/16"	3/16"	2-3/4"
GMA24010	6	1/2"	7/32"	3"
GMA24011	7	5/8"	1/4"	3-1/4"
GMA24012	8	3/4"	5/16"	3-1/2"
GMA24013	9	7/8"	11/32"	3-5/8"
GMA24014	10	1"	3/8"	3-3/4"

Art No.	Bell Type			
	Number	D	d	L
GMA24015	11	1/8"	3/64"	1-1/4"
GMA24016	12	3/16"	5/64"	1-7/8"
GMA24017	13	1/4"	7/64"	2"
GMA24018	14	5/16"	1/8"	2-1/8"
GMA24019	15	7/16"	3/16"	2-3/4"
GMA24020	16	1/2"	7/32"	3"
GMA24021	17	5/8"	1/4"	3-1/4"
GMA24022	18	3/4"	5/16"	3-1/2"
GMA24023	19	7/8"	11/32"	3-5/8"
GMA24024	20	1"	3/8"	3-3/4"

Art No.	Inch Long Series			
	Number	D	d	L
GMA24025	1	1/8"	3/64"	3
GMA24026	1	1/8"	3/64"	4
GMA24027	1	1/8"	3/64"	5
GMA24028	1	1/8"	3/64"	6
GMA24029	2	3/16"	5/64"	4
GMA24030	2	3/16"	5/64"	5
GMA24031	2	3/16"	5/64"	6
GMA24032	3	1/4"	7/64"	4
GMA24033	3	1/4"	7/64"	5
GMA24034	3	1/4"	7/64"	6
GMA24035	4	5/16"	1/8"	4
GMA24036	4	5/16"	1/8"	5
GMA24037	4	5/16"	1/8"	6
GMA24038	4-1/2"	3/8"	9/64"	4
GMA24039	4-1/2"	3/8"	9/64"	5
GMA24040	4-1/2"	3/8"	9/64"	6
GMA24041	5	7/16"	3/16"	4
GMA24042	5	7/16"	3/16"	5
GMA24043	5	7/16"	3/16"	6
GMA24044	6	1/2"	7/32"	5
GMA24045	6	1/2"	7/32"	6
GMA24046	7	5/8"	1/4"	6
GMA24047	8	3/4"	5/16"	6





HSS Step Drill

DIN 335 HSS ground type C 90° Countersink

Art No.	Size	Increment	No. of Step	Shank
GMA25001	4-12	1mm	9	6mm
GMA25002	4-12	2mm	5	6mm
GMA25003	4-20	2mm	9	8mm
GMA25004	4-22	2mm	10	8mm
GMA25005	4-30	2mm	14	10mm
GMA25006	4-32	2mm	15	10mm
GMA25007	5-35	2-3mm	13	13mm
GMA25008	6-12	1mm	7	8mm
GMA25009	6-18	2mm	7	10mm
GMA25010	6-20	2mm	8	10mm
GMA25011	6-30	2mm	13	10mm
GMA25012	6-30	2-3mm	12	10mm
GMA25013	6-38	2-3mm	12	10mm
GMA25014	9-36	3mm	10	10mm
GMA25015	10-20	1mm	11	10mm
GMA25016	10-45	5mm	8	13mm
GMA25017	12-20	1mm	9	10mm
GMA25018	14-24	2mm	6	13mm
GMA25019	20-30	1mm	11	13mm
GMA25020	20-34	2mm	8	13mm

Art no	Max Dia.	Min Dia.	Oal.	Shank Dia
GMA25028	4.3	1.3	40	4
GMA25029	5.0	1.5	40	4
GMA25030	5.3	1.5	40	4
GMA25031	6.0	1.5	46	5
GMA25032	6.3	1.5	46	6
GMA25033	7.0	1.8	50	6
GMA25034	7.3	1.8	50	6
GMA25035	8.0	2.0	50	6
GMA25036	8.3	2.0	50	6
GMA25037	9.4	2.2	50	6
GMA25038	10.0	2.5	50	6
GMA25039	10.4	2.5	50	6
GMA25040	11.5	2.8	58	8
GMA25041	12.4	2.8	58	8
GMA25042	13.4	2.9	60	10
GMA25043	15.0	3.2	60	10
GMA25044	16.0	3.2	60	10
GMA25045	19.0	3.5	63	10
GMA25046	20.5	3.8	63	10
GMA25047	23.0	3.8	67	10
GMA25048	25.0	3.2	67	10
GMA25049	26.0	3.3	67	10
GMA25050	28.0	4.0	71	12
GMA25051	30.0	4.2	71	12
GMA25052	31.0	4.2	71	12

Art No.	Size	Increment	No. of Step	Shank
GMA25021	1/8"-1/2"	1/32"	13	1/4"
GMA25022	3/16"-1/2"	1/16"	6	1/4"
GMA25023	1/4"-3/4"	1/16"	9	3/8"
GMA25024	3/16"-7/8"	1/16"	12	3/8"
GMA25025	9/16"-1"	1/16"	8	1/2"
GMA25026	13/16"-1-3/8"	1/16"	10	1/2"
GMA25027	1/4"-1-3/8"	1/8"	10	1/2"





Wood Working Drill

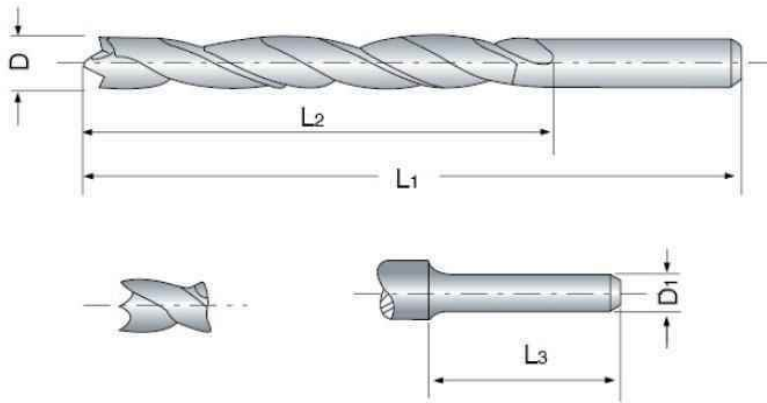

Art No.	D	L1	L2	D1	L3	Art No.	D	L1	L2	D1	L3
GMA26001	3.00	60	32			GMA26027	3.5	70	38		
GMA26002	4.00	75	43			GMA26028	4.5	80	45		
GMA26003	5.00	85	51			GMA26029	5.5	92	54		
GMA26004	6.00	92	54			GMA26030	6.5	100	60		
GMA26005	7.00	100	60			GMA26031	7.5	105	60		
GMA26006	8.00	115	71			GMA26032	8.5	115	71		
GMA26007	9.00	115	71			GMA26033	9.5	115	85		
GMA26008	10.00	120	82			GMA26034	10.5	130	82		
GMA26009	11.00	140	90			GMA26035	11.5	140	90		
GMA26010	12.00	140	90			GMA26036	12.5	150	95	12	20
GMA26011	13.00	150	95	12	20	GMA26037	13.5	150	95	12	20
GMA26012	14.00	150	95	12	20	GMA26038	14.5	160	100	12	20
GMA26013	15.00	160	100	12	20	GMA26039	15.5	160	100	12	20
GMA26014	16.00	160	100	12	20	GMA26040	16.5	170	115	12	20
GMA26015	18.00	170	115	12	20	GMA26041	18.5	170	115	12	20
GMA26016	20.00	180	130	12	20						
GMA26017	22.00	200	150	20	30						
GMA26018	24.00	200	150	20	30						
GMA26019	26.00	250	170	20	30						
GMA26020	28.00	250	170	20	30						
GMA26021	30.00	260	180	20	30						
GMA26022	32.00	280	195	20	30						
GMA26023	34.00	285	200	20	30						
GMA26024	36.00	290	205	20	30						
GMA26025	38.00	295	210	20	30						
GMA26026	40.00	300	215	20	30						

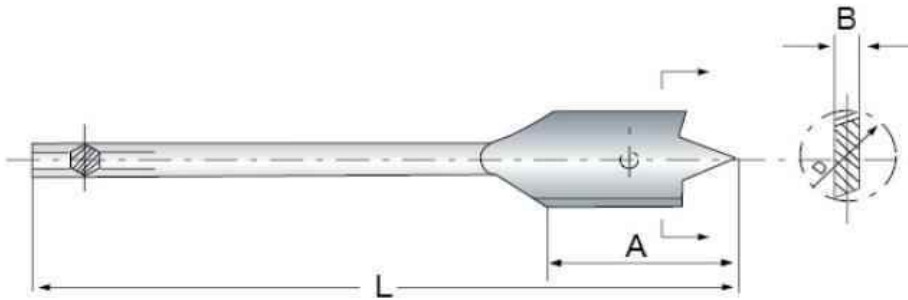

6" Wood Flat Bit

Art No.	D		L		A	B
	Size	In	Length	ToL.		
GMA27001	6.00	1/4"	150	±3	32	2.2
GMA27002	7.00	9/32"	150	±3	32	2.2
GMA27003	8.00	5/16"	150	±3	32	2.2
GMA27004	9.00	11/32"	150	±3	35	2.2
GMA27005	10.00	3/8"	150	±3	35	2.4
GMA27006	11.00	7/16"	150	±3	35	2.4
GMA27007	12.00	15/32"	150	±3	38	2.4
GMA27008	14.00	9/16"	150	±3	38	2.4
GMA27009	16.00	5/8"	150	±3	38	2.5
GMA27010	18.00	11/16"	150	±3	38	2.5
GMA27011	20.00	25/32"	150	±3	38	2.6
GMA27012	22.00	7/8"	150	±3	38	2.6
GMA27013	25.00	1"	150	±3	45	2.6
GMA27014	28.00	1-1/8"	150	±3	45	2.8
GMA27015	32.00	1-1/4"	150	±3	54	2.8
GMA27016	35.00	1-3/8"	150	±3	54	2.8
GMA27017	40.00	1-9/16"	150	±3	54	2.8



12" Long Wood Flat Bit

Art No.	D		L		A	B
	Size	In	Length	ToL.		
GMA27018	6.00	1/4"	300	±3	32	2.2
GMA27019	7.00	9/32"	300	±3	32	2.2
GMA27020	8.00	5/16"	300	±3	32	2.2
GMA27021	9.00	11/32"	300	±3	35	2.2
GMA27022	10.00	3/8"	300	±3	35	2.4
GMA27023	11.00	7/16"	300	±3	35	2.4
GMA27024	12.00	15/32"	300	±3	38	2.4
GMA27025	14.00	9/16"	300	±3	38	2.4
GMA27026	16.00	5/8"	300	±3	38	2.5
GMA27027	18.00	11/16"	300	±3	38	2.5
GMA27028	20.00	25/32"	300	±3	38	2.6
GMA27029	22.00	7/8"	300	±3	38	2.6
GMA27030	25.00	1"	300	±3	45	2.6
GMA27031	28.00	1-1/8"	300	±3	45	2.8
GMA27032	32.00	1-1/4"	300	±3	54	2.8
GMA27033	35.00	1-3/8"	300	±3	54	2.8
GMA27034	40.00	1-9/16"	300	±3	54	2.8



Auger Bit

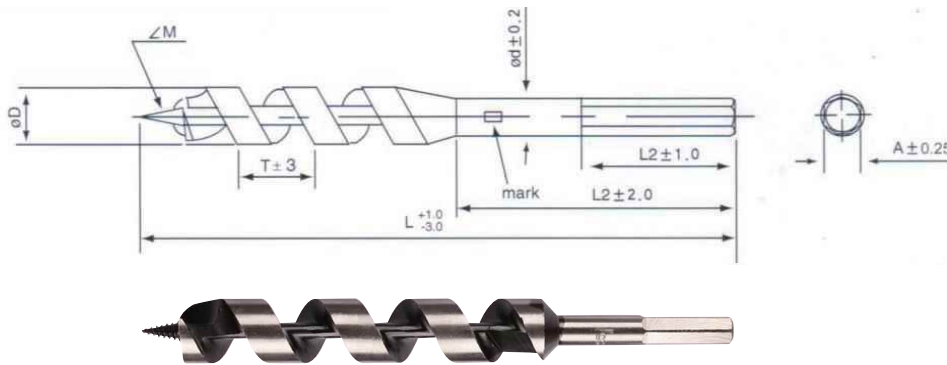

Art No.	DIA(mm)	D(mm)	L(mm)	L1(mm)	L2(mm)	A(mm)	T(mm)	M(mm)	D(mm)	
GMA28001	6	6	0 -0.08	75 100 150 200			5.00	18.00	1.25	5.60
GMA28002	8	8	0 -0.1	230 250			6.70	18.00	1.50	7.60
GMA28003	10	10	0 -0.12	300 400 460			8.70	20.00	1.50	9.60
GMA28004	12	12	0 -0.13	500 600			10.70	24.00	1.75	11.60
GMA28005	14	14	0 -0.13				11.20	28.00	1.75	12.50
GMA28006	16	16	0 -0.13				11.20	28.00	1.75	12.50
GMA28007	18	18	0 -0.15				11.20	32.00	2.00	12.50
GMA28008	20	20	0 -0.15		L75 L1=35 L100 L1=40	L1=35 L2=25	11.20	32.00	2.00	12.50
GMA28009	22	22	0 -0.2	100 150	L101-149 L1=50 L150-200 L1=60	L1≤60 L2=28	11.20	36.00	2.00	12.50
GMA28010	24	24	0 -0.2	200 230	L201-320 L1=75 L330-400 L1=80	L1>60 L2=232	11.20	36.00	2.00	12.50
GMA28011	26	26	0 -0.2	400 460	L460-1500 L1=100		11.20	40.00	2.50	12.50
GMA28012	28	28	0 -0.2	500 600			11.20	40.00	2.50	12.50
GMA28013	30	30	0 -0.2	900			11.20	44.00	2.50	12.50
GMA28014	32	32	0 -0.2	1200 1500			11.20	44.00	2.50	12.50
GMA28015	34	34	0 -0.2				11.20	44.00	2.50	12.50
GMA28016	36	36	0 -0.2				11.20	44.00	2.50	12.50
GMA28017	38	38	0 -0.2				11.20	44.00	2.50	12.50
GMA28018	40	40	0 -0.2				11.20	44.00	2.50	12.50



Masonry Drill Q/32181 RFD004(0)

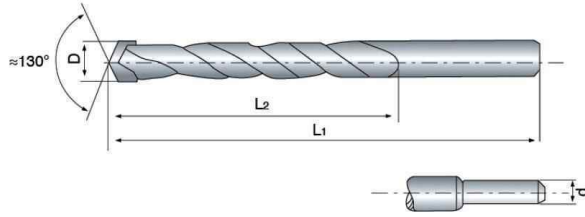

mm

Art No.	D	+IT14	+IT12	Stub Series Length		Jobbers Length		Long Length		Extra Long Length		d
				L1	≈L2	L1	≈L2	L1	≈L2	L1	≈L2	
GMA29001	3.0	+0.25	+0.10	60	30	-	-					
GMA29002	4.0	+0.30	+0.12	75	50	-	-					
GMA29003	4.5	+0.30	+0.12	85	55	150	85					
GMA29004	5.0	+0.30	+0.12	85	55	150	85					
GMA29005	5.5	+0.30	+0.12	85	55	150	85					
GMA29006	6.0	+0.30	+0.12	100	65	150	85					
GMA29007	6.5	+0.36	+0.15	100	65	150	85					
GMA29008	7.0	+0.36	+0.15	100	65	150	85					
GMA29009	8.0	+0.36	+0.15	120	80	200	135					
GMA29010	8.5	+0.36	+0.15	120	80	200	135					
GMA29011	9.0	+0.36	+0.15	120	80	200	135					
GMA29012	10.0	+0.36	+0.15	120	80	200	135					
GMA29013	11.0	+0.43	+0.18	150	90	200	135					10
GMA29014	12.0	+0.43	+0.18	150	90	220	150	400	350	600	550	10
GMA29015	13.0	+0.43	+0.18	150	90			400	350	600	550	10
GMA29016	14.0	+0.43	+0.18	150	90			400	350	600	550	13
GMA29017	16.0	+0.43	+0.18	150	90			400	350	600	550	13
GMA29018	18.0	+0.43	+0.18	160	100			400	350	600	550	13
GMA29019	20.0	+0.52	+0.21	160	100			400	350	600	550	13or16
GMA29020	22.0	+0.52	+0.21	160	100			400	350	600	550	13or16
GMA29021	24.0	+0.52	+0.21	160	100			400	350	600	550	13or16
GMA29022	25.0	+0.52	+0.21	160	100					600	550	13or16

Masonry Drill DIN8039

mm



Art No.	d1	Tol.	d2	L1	L2 ≈	L3
GMA30001	4.0	+0.12		70	40	
GMA30002	4.5	+0.12		70	40	
GMA30003	5.0	+0.12		80	50	
GMA30004	5.5	+0.12		80	50	
GMA30005	6.0	+0.12		100	60	
GMA30006	6.5	+0.12		100	60	
GMA30007	7.0	+0.15		110	60	
GMA30008	7.5	+0.15		110	60	
GMA30009	8.0	+0.15		125	80	
GMA30010	8.5	+0.15		125	80	
GMA30011	9.0	+0.15		125	80	
GMA30012	9.5	+0.15		125	80	
GMA30013	10.0	+0.15		125	80	
GMA30014	10.5	+0.18		125	80	
GMA30015	11.0	+0.18		140	90	
GMA30016	12.0	+0.18	10	140	90	40
GMA30017	13.0	+0.18	10	140	90	40
GMA30018	14.0	+0.18	10	140	90	40
GMA30019	15.0	+0.18	10	140	90	40
GMA30020	16.0	+0.18	13	140	90	45
GMA30021	17.0	+0.18	13	140	90	45
GMA30022	18.0	+0.18	13	160	100	45
GMA30023	19.0	+0.21	13	160	100	45
GMA30024	20.0	+0.21	13	160	100	45



Electric Hammer Drill JB/T8368.1(0)

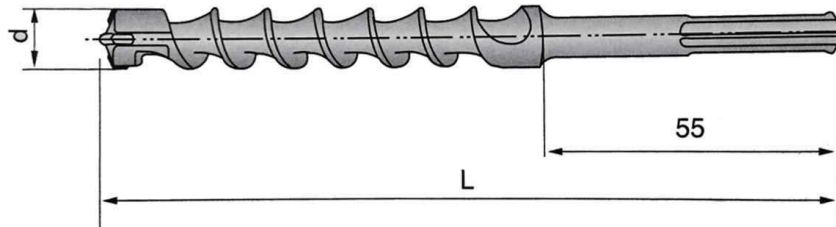

Art No.	d		L			
	mm	ToL.	Stub	Jobbers	Long	Extra Long
GMA31001	5	+0.3	110	160	210	
GMA31002	6	+0.12	110	160	210	
GMA31003	7	+0.36	110	160	210	
GMA31004	8	+0.15	110	160	210	
GMA31005	10	+0.15	110	160	210	310
GMA31006	12	+0.43	160	160	210	310
GMA31007	14	+0.43	160	160	210	310
GMA31008	16	+0.18	160	210	210	310
GMA31009	18	+0.18	160	210	210	310
GMA31010	20	+0.52	160	210	360	310
GMA31011	22	+0.52	210	210	360	460
GMA31012	24	+0.21	210	310	360	460
GMA31013	26	+0.21	210	310	360	460
GMA31014	28	+0.21	260	310	460	610
GMA31015	32	+0.62	260	310	460	610
GMA31016	35	+0.62	260	310	460	610
GMA31017	38	+0.62	260	310	460	610
GMA31018	40	+0.62	260	360	460	610
GMA31019	42	+0.25	260	360	460	610
GMA31020	45	+0.25	260	360	460	610
GMA31021	50	+0.25	260	360	460	610



Electric Hammer Drill DIN8035(B)

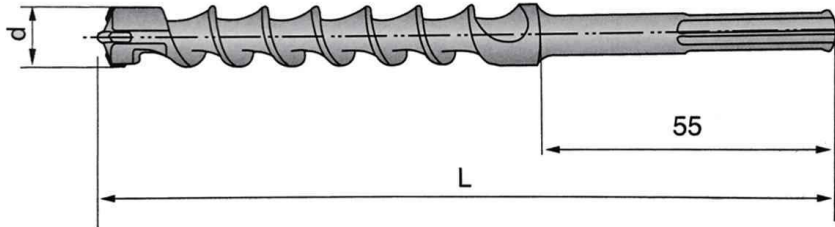

Art No.	Stub Series Length			L
	d			
GMA32001	5	+0.35	+0.15	90
GMA32002	(7)	+0.45	+0.2	105
GMA32003	8	+0.45	+0.2	105
GMA32004	10	+0.45	+0.2	135
GMA32005	12	+0.50	+0.2	135
GMA32006	14	+0.50	+0.2	155
GMA32007	16	+0.50	+0.2	155
GMA32008	17	+0.50	+0.2	205
GMA32009	18	+0.50	+0.2	205
GMA32010	19	+0.55	+0.21	205
GMA32011	20	+0.55	+0.21	205

Art No.	Extra Long Length			L
	d			
GMA32012	10	+0.45	+0.2	155
GMA32013	12	+0.5	+0.2	455
GMA32014	16	+0.5	+0.2	605
GMA32015	20	+0.55	+0.21	605
GMA32016	25	+0.55	+0.21	605
GMA32017	28	+0.55	+0.21	605
GMA32018	35	+0.7	+0.25	605
GMA32019	44	+0.8	+0.25	605
GMA32020	52	+0.95	+0.3	605

Art No.	Jobbers Length			Art No.	Long Length				
	d		L		d		L		
GMA32021	5	+0.35	+0.15	105	GMA32047	5	+0.35	+0.15	135
GMA32022	6	+0.45	+0.15	105	GMA32048	6	+0.45	+0.15	155
GMA32023	(7)	+0.45	+0.20	155	GMA32049	()	+0.45	+0.20	205
GMA32024	8	+0.45	+0.20	155	GMA32050	7	+0.45	+0.20	205
GMA32025	9	+0.45	+0.20	155	GMA32051	8	+0.45	+0.20	205
GMA32026	10	+0.45	+0.20	155	GMA32052	9	+0.45	+0.20	205
GMA32027	(11)	+0.50	+0.20	155	GMA32053	10	+0.50	+0.20	205
GMA32028	12	+0.50	+0.20	205	GMA32054	()	+0.50	+0.20	255
GMA32029	13	+0.50	+0.20	205	GMA32055	11	+0.50	+0.20	255
GMA32030	14	+0.50	+0.20	205	GMA32056	12	+0.50	+0.20	255
GMA32031	15	+0.50	+0.20	205	GMA32057	13	+0.50	+0.20	255
GMA32032	16	+0.50	+0.20	255	GMA32058	14	+0.50	+0.20	455
GMA32033	18	+0.50	+0.20	255	GMA32059	15	+0.55	+0.21	455
GMA32034	19	+0.55	+0.21	255	GMA32060	16	+0.55	+0.21	455
GMA32035	20	+0.55	+0.21	255	GMA32061	20	+0.55	+0.21	455
GMA32036	22	+0.55	+0.21	255	GMA32062	22	+0.55	+0.21	455
GMA32037	24	+0.55	+0.21	255	GMA32063	24	+0.55	+0.21	455
GMA32038	25	+0.55	+0.21	255	GMA32064	25	+0.55	+0.21	455
GMA32039	28	+0.55	+0.21	305	GMA32065	28	+0.55	+0.21	455
GMA32040	30	+0.55	+0.21	305	GMA32066	30	+0.70	+0.25	455
GMA32041	32	+0.70	0.25	305	GMA32067	32	+0.70	+0.25	455
GMA32042	35	+0.70	0.25	305	GMA32068	35	+0.70	+0.25	455
GMA32043	37	+0.70	0.25	305	GMA32069	37	+0.70	+0.25	455
GMA32044	40	+0.80	0.25	305	GMA32070	40	+0.80	+0.25	455
GMA32045	44	+0.80	0.25	305		44	+0.80	+0.25	455
GMA32046	52	+0.95	0.30	305		52	+0.95	+0.30	455



Glass And Ceramic Drill

Art No.	d	L
GMA33001	3	60
GMA33002	4	60
GMA33003	5	70
GMA33004	6	75
GMA33005	7	75
GMA33006	8	80
GMA33007	9	85
GMA33008	10	85
GMA33009	12	100
GMA33010	13	100



SDS Plus Chisel

Art No.	dxL	Shank	Type
GMA34001	3.2x250	H14	Point
GMA34002	3.2x300	H14	Point
GMA34003	3.2x400	H14	Point
GMA34004	20x250	H14	Flat
GMA34005	22x250	H14	Flat
GMA34006	22x300	H14	Flat
GMA34007	22x400	H14	Flat
GMA34008	40x250	H14	Flat
GMA34009	22x26x250	H14	Hollow
GMA34010	22x26x400	H14	Hollow



SDS Chuck Adaptor

Art No.	Size
GMA35001	1/2"x20UNF
GMA35002	3/8"x24UNF



SDS Max Chisel

Art No.	dxL	Shank	Type
GMA34011	3.2x280	H18	Point
GMA34012	3.2x350	H18	Point
GMA34013	3.2x400	H18	Point
GMA34014	3.2x450	H18	Point
GMA34015	3.2x500	H18	Point
GMA34016	3.2x600	H18	Point
GMA34017	25x280	H18	Flat
GMA34018	25x400	H18	Flat
GMA34019	25x500	H18	Flat
GMA34020	25x600	H18	Flat
GMA34021	50x400	H18	Flat
GMA34022	25x400	H18	Hollow



HSS Fully Ground Saw Drill 135° Split Point

Art No.	Dia.	Order No.	Dia.
GMA36001	3		1/8
GMA36002	4		5/32
GMA36003	5		3/16
GMA36004	6		7/32
GMA36005	6.5		1/4
GMA36006	8		5/16
GMA36007	9		23/64
GMA36008	9.5		3/8
GMA36009	10		25/64
GMA36010	11		7/16
GMA36011	12		15/32
GMA36012	13		1/2





HSS Annular Cutter (Weldom Shank)

Art No.	Dia.	Cutting	Oal	Art No.	Dia.	Cutting	Oal
GMA37001	12.0	30	63	GMA38001	12.0	50	88
GMA37002	13.0	30	63	GMA38002	13.0	50	88
GMA37003	14.0	30	63	GMA38003	14.0	50	88
GMA37004	15.0	30	63	GMA38004	15.0	50	88
GMA37005	16.0	30	63	GMA38005	16.0	50	88
GMA37006	17.0	30	63	GMA38006	17.0	50	88
GMA37007	18.0	30	63	GMA38007	18.0	50	88
GMA37008	19.0	30	63	GMA38008	19.0	50	88
GMA37009	20.0	30	63	GMA38009	20.0	50	88
GMA37010	21.0	30	63	GMA38010	21.0	50	88
GMA37011	22.0	30	63	GMA38011	22.0	50	88
GMA37012	23.0	30	63	GMA38012	23.0	50	88
GMA37013	24.0	30	63	GMA38013	24.0	50	88
GMA37014	25.0	30	63	GMA38014	25.0	50	88
GMA37015	26.0	30	63	GMA38015	26.0	50	88
GMA37016	27.0	30	63	GMA38016	27.0	50	88
GMA37017	28.0	30	63	GMA38017	28.0	50	88
GMA37018	29.0	30	63	GMA38018	29.0	50	88
GMA37019	30.0	30	63	GMA38019	30.0	50	88
GMA37020	31.0	30	63	GMA38020	31.0	50	88
GMA37021	32.0	30	63	GMA38021	32.0	50	88
GMA37022	33.0	30	63	GMA38022	33.0	50	88
GMA37023	34.0	30	63	GMA38023	34.0	50	88
GMA37024	35.0	30	63	GMA38024	35.0	50	88
GMA37025	36.0	30	63	GMA38025	36.0	50	88
GMA37026	37.0	30	63	GMA38026	37.0	50	88
GMA37027	38.0	30	63	GMA38027	38.0	50	88
GMA37028	39.0	30	63	GMA38028	39.0	50	88
GMA37029	40.0	30	63	GMA38029	40.0	50	88
GMA37030	41.0	30	63	GMA38030	41.0	50	88
GMA37031	42.0	30	63	GMA38031	42.0	50	88
GMA37032	43.0	30	63	GMA38032	43.0	50	88
GMA37033	44.0	30	63	GMA38033	44.0	50	88
GMA37034	45.0	30	63	GMA38034	45.0	50	88
GMA37035	46.0	30	63	GMA38035	46.0	50	88
GMA37036	47.0	30	63	GMA38036	47.0	50	88
GMA37037	48.0	30	63	GMA38037	48.0	50	88
GMA37038	49.0	30	63	GMA38038	49.0	50	88
GMA37039	50.0	30	63	GMA38039	50.0	50	88

mm





GMA001

5pcs Twist drill bits set
Size: 2, 3, 4, 5, 6mm



GMA002

6pcs Twist drill bits set
Size: 2, 3, 4, 5, 6, 8mm

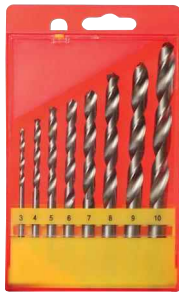

GMA003

8pcs Twist drill bits set
Size: 3, 4, 5, 6, 7, 8, 9, 10mm



GMA004

7pcs HSS tin coated long length drill bits set
Size: 2 pcs x 6mm, 2 pcs x 8mm
2 pcs x 10mm, 1 pc x 12mm
Total Length: 275mm



GMA005

10pcs combination set
Drill: 5/64", 7/64", 5/32", 1/4", 19/64"
Extractor: #1~#5



GMA006

13pcs Twist drill bits set
Size: 1/16"-1/4" x 1/64"



GMA007

15pcs Left hand twist drill set

Size: 1/16", 3/32", 1/8", 5/32", 3/16",
7/32", 1/4", 9/32", 5/16", 11/32",
3/8", 13/32", 7/16", 15/32", 1/2"



GMA008

16pcs combination drill set

Size: 2, 3, 4, 5, 6, 8 (twist)
4,5,6,8,10 (concrete)
4, 5, 6, 8, 10 (wood)



GMA009

19pcs Twist drill bits set

Size: 1.0-10.0mm x 0.5mm



GMA010

19pcs Twist drill bits set

Size: 1.0-10.0mm x 0.5mm



GMA011

21pcs Twist drill bits set

Size: 1/16"~3/8" x 1/64"



GMA012

25pcs Twist drill bits set

Size: 1.0-13.0mm x 0.5mm



GMA013

29pcs Twist drill bits set

Size: 1/16"-1/2" x 1/64"



GMA014

51pcs Twist drill bits set

Size: 1.0-6.0mm x 0.1mm



GMA015

115pcs Twist drill bits set

Size: A-Z, 1#-60#, 1/16"-1/2"



GMA016

170pcs Twist drill bits set

Size: 1.0-8.0 x 0.5mm x 10pcs
+ 8.5-10.0 x 0.5mm x 5pcs



GMA017

230pcs Twist drill bits set

Size: 1.0, 1.5, 2.0, 2.5, 3.0, 3.2, 3.5, 4.0, 4.2, 4.5,
5.0, 5.5, 6.5, 7.0, 7.5, 8.0, 8.5, 10.0 x 10pcs +
9.0, 9.5, 10.5, 11.0, 11.5, 12.0, 12.5, 13.0 x 5pcs



GMA018

8 pcs HSS reduced shank drill

Size: 1-1/16", 1-1/8", 1-3/16", 1-1/4", 1-5/16",
1-3/8", 1-7/16", 1-1/2" with 1/2" shank



GMDB029

29pcs Twist Drill bit set

Size:1/16"-1/2"X1/64"



GMDB030

29pcs Twist Drill bit set

Size:1/16"-1/2"X1/64"



GMDB031

29pcs Twist Drill bit set

Size:1/16"-1/2"X1/64"



GMDB032

3pcs Step drill bit

Size:1/16"X2,5/64"X2,3/32"X2,7/64", 1/8",5/32",
11/64",3/16",1/4",5/16",3/8"



GMDB033

19pcs Twist Drill bit set

Size:1.0-10.0mmX0.5mm



GMDB034

25pcs Twist Drill bit set

Size:1.0-13.0mmX0.5mm



GMDB035

29pcs Twist Drill bit set



GMDB036

29pcs Twist Drill bit set



GMDB037

29pcs Twist Drill bit set



GMDB038

3pcs Step drill bit



GMDB039

25pcs Twist Drill bit set



GMDB040

13pcs Twist Drill bit set



GMDB041

3pcs Step Drill Set



GMDB042

7pcs Step Drill Set



GMDB043

4pcs Step Drill Set



GMDB044

13pcs Flap Wood Drill set



GMDB045

6pcs Flat Wood Drill Set



GMDB046

12pcs Wood Drill set



GMDB047

13pcs Flat Wood Drill set



GMDB048

6pcs Wood Drill set



GMDB049

6pcs Auger Drill bits



GMDB050

8pcs Auger Drill bits



GMDB051

7pcs Auger Drill bits

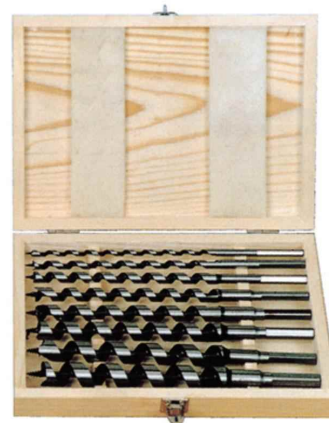

GMDB052

8pcs Twist Drill bit set



GMDB053

3pcs Masonry Drill Set



GMDB054

6pcs Masonry Drill Set



GMDB055

5pcs SDS Drill Set



GMDB056

8pcs SDS Drill Set



GMDB057

10pcs SDS Drill Set



GMDB058

11pcs SDS Drill Set



GMDB059

12pcs SDS Drill Set



GMDB060

12pcs SDS Drill Set



GMDB061

14pcs SDS Drill Set



GMDB062

14pcs SDS Drill Set



GMDB063

18pcs SDS Drill Set



GMDB064

56pcs SDS Drill Set



GMDB065

26pcs Combination Drill Bit Set

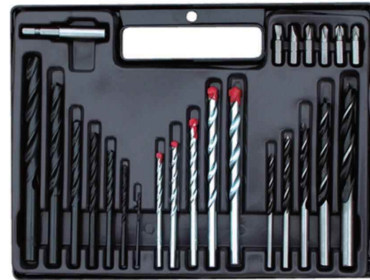

GMDB066

24pcs Combination Drill Bit Set



GMDB067

18pcs Combination Drill Bit Set



GMDB068

27pcs Combination Drill Bit Set



GMDB069

42pcs Combination Drill Bit Set



GMDB070

44pcs Combination Drill Bit Set



GMDB070

46pcs Combination Drill Bit Set



GMDB071

46pcs Combination Drill Bit Set



GMDB072

18pcs Combination Drill Bit Set



GMDB073

52pcs Combination Drill Bit Set



GMDB074

42pcs Combination Drill Bit Set



GMDB075

44pcs Combination Drill Bit Set

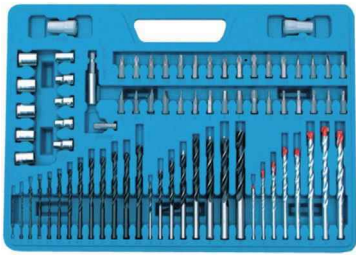

GMDB076

75pcs Combination Drill Bit Set



GMDB077

92pcs Combination Drill Bit Set



GMDB078

96pcs Combination Drill Bit Set



GMDB079

99pcs Combination Drill Bit Set



GMDB080

100pcs Combination Drill Bit Set



GMDB081

125pcs Combination Drill Bit Set



GMDB082

42pcs Combination Drill Bit Set



GMDB083

52pcs Combination Drill Bit Set



GMDB084

60pcs Combination Drill Bit Set



GMDB085

49pcs Combination Drill Bit Set



GMDB086

81pcs Combination Drill Bit Set



GMDB087

51pcs Combination Drill Bit Set



GMDB088

100pcs Combination Drill Bit Set



GMDB089

101pcs Combination Drill Bit Set



GMDB090

116pcs Combination Drill Bit Set



GMDB091

50pcs Combination Drill Bit Set



GMDB092

109pcs Combination Drill Bit Set



GMDB093

116pcs Combination Drill Bit Set



GMDB094

250pcs Combination Drill Bit Set



GMDB095

400pcs Combination Drill Bit Set





GMA019

8pcs HSS reduced shank drill

Size: 9/16"- 5/8"- 11/16"- 3/4"-13/16"
-7/8"- 15/16" -1" with 1/2" shank



GMA020

17pcs HSS reduced shank drill

Size: 1/2"-17/32"-9/16"-19/32"-5/8"-21/32"
-11/16"-23/32"-3/4"-25/32"-13/16"-27/32"
-7/8"-29/32"-15/16"-31/32"-1" with 1/2" shank



GMA021

10pcs Taper shank drill bits set

Size: 14, 15, 16, 17, 18, 19, 20, 21, 22, 23mm



GMA022

12pcs HSS center drills set in wooden box

Size: 1mm-1.6mm-5mm x 1 pcs ;
2mm-2.5mm-4mm x 2 pcs ;
3.15mm x 3 pcs



GMA023

3pcs HSS step drill bits set

Size: 4-12mm x 5 step
4-20mm x 9 step
4-32mm x 15 step



GMA024

3pcs HSS step drill bits set

Size: 4-12mm x 9 step
6-20mm x 8 step
6-30mm x 13 step



GMA025

3pcs HSS conical drill bits set

Size: 3-14mm; 8-20mm; 16-30mm



GMA026

3pcs HSS spiral grooved step drill bits set

Size: 4-12mm x 5 step
4 - 20mm x 9 step
4 - 32mm x 15 step



GMA027

4pcs HSS spiral grooved step drill bits set

Size: 1/8"-1/2" x 13 step
1/4"-3/4" x 9 step
3/16"-7/8" x 12 step
1/2"-1" x 9 step



GMA028

5pcs HSS countersink bits set

Size: 1/4", 3/8", 1/2", 5/8", 3/4" (5 flutes)



GMA029

5pcs HSS step drill bits set

Size: 4-12mm x 9 step
4-20mm x 9 step
5-28mm x 7 step
4-30mm x 14 step
4-39mm x 13 step



GMA030

5pcs HSS step drill bits set

Size: 3/16"-1/2" x 6 step
1/8"-1/2" x 13 step
1/4"-3/4" x 9 step
1/4"-1-3/8" x 10 step
3/16"-7/8" x 12 step



GMA031

4pcs Wood flat drill bits set

Size: 16, 22, 25, 32mm



GMA032

6pcs Wood flat drill bits set

Size: 10, 12, 16, 18, 20, 25mm



GMA033

6pcs Long spade bits set

Size: 10, 12, 16, 18, 20, 25mm



GMA034

6pcs Long spade bits set

Size: 10, 12, 16, 18, 20, 25mm



GMA035

7pcs Wood flat drill bits set

Size: 10, 12, 16, 19, 22, 25, 32mm



GMA036

10pcs Wood flat drill bits set

Size: 6, 10, 13, 16, 20, 22, 25, 32mm

1pc 300mm extension rods

1pc hex key



GMA037

5pcs Wood working drill bits set

Size: 4, 5, 6, 8, 10mm



GMA038

8pcs Wood working drill bits set

Size: 3, 4, 5, 6, 7, 8, 9, 10mm



GMA039

29pcs Wood working drill bits set

Size: 1/16"-1/2" x 1/64



GMA040

6pcs Wood auger drill bits set

Size: 8, 10, 12, 14, 16, 18mm x 230mm



GMA041

6pcs Wood auger drill bits set

Size: 10, 13, 16, 19, 22, 25mm x 120mm



GMA042

7pcs Wood auger drill bits set

Size: 1/4", 3/8", 1/2", 5/8", 3/4", 7/8", 1" x 9"



GMA043

7pcs Wood drill bits set

Size: 4, 5, 6, 7, 8, 10, 12mm



GMA044

7pcs Auger bits with 1/4" hexagonal shaft

Size: 10, 12, 14, 16, 18, 20, 22mm x 150mm



GMA045

8pcs Wood auger drill bits set

Size: 6, 8, 10, 13, 16, 19, 22, 25mm x 230mm



GMA046

8pcs Wood auger drill bits set

Size: 6, 8, 10, 13, 16, 19, 22, 25mm x 200mm



GMA047

5pcs Masonry drill bits set

Size: 4, 5, 6, 8, 10mm



GMA048

3pcs Long masonry drill bits set

Size: 8, 10, 12mm x 400mm



GMA049

5pcs Masonry drill bits set

Size: 4, 5, 6, 8, 10mm



GMA050

7pcs Universal drill bits set

Size: 4, 5, 6, 7, 8, 10mm



GMA051

8pcs Masonry drill bits set

Size: 3, 4, 5, 6, 7, 8, 9, 10mm



GMA052

3pcs SDS hammer drill bits set

Size: 6, 8, 10mm x 160mm



GMA053

5pcs SDS-plus drill bits set

Size: 6 x 110, 8 x 110, 10 x 110,
6 x 160, 8 x 160, 10 x 160mm



GMA054

7pcs SDS-plus drill bits set

Size: 5 x 110, 6 x 110, 5 x 160, 6 x 160,
8 x 160, 10 x 160, 12 x 160mm



GMA055

6pcs SDS-plus drill bits set

Size: 10, 12, 14, 16, 18, 20 x 450mm

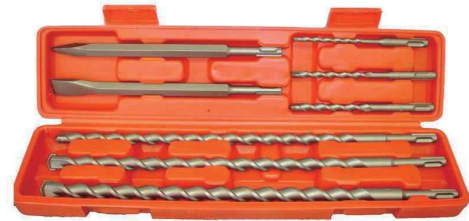

GMA056

8pcs SDS hammer drill bits set

Drill: 6, 8, 10mm x 160mm; 14, 16, 18mm x 400mm;
Flat chisel: 14 x 250mm;
Point chisel: 14 x 250mm



GMA057

5pcs SDS-max shank chisel set

Include: 2pcs of pointed chisels
2pcs of small flat chisels
1pc of big flat chisel

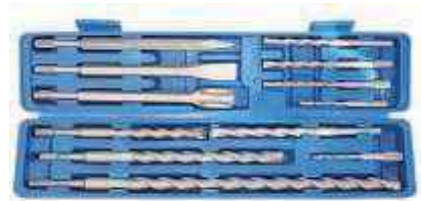

GMA058

12pcs SDS-plus drill bits set

Drill: 5, 6 x 110mm; 8, 10, 12 x 160mm;
14, 16 x 210mm; 18 x 310mm;
20x450 mm
Point chisel: 14 x 250mm
Flat chisel: 14 x 250mm
Gouge chisel: 14x250mm



GMA059

13pcs SDS-plus drill bits set

Drill: 6, 8, 10 x 160mm; 8, 10, 12 x 210mm;
10, 12, 14 x 260mm
Point chisel: 14 x 250mm
Flat chisel: 14 x 250mm
Spade chisel: 14 x 250mm



GMA060

17pcs SDS plus drill bits set

Drill: 5, 6, 8, 10 x 110mm; 6, 8, 10, 12 x 160mm
Point chisel: 140, 250mm
Flat chisel: 20 x 140, 20 x 250, 40 x 250mm



GMA061

50pcs SDS-plus drill bits set

Size: 110mm x 5pcs;

10, 12 x 160mm x 5pcs;

6, 8 x 160mm x 10pcs;

8, 10, 12 x 210mm x 5pcs



GMA062

6pcs Glass drill bits set

Size: 3, 4, 5, 6, 8, 10mm



GMA063

6pcs Glass drill bits set

Size: 3, 4, 5, 6, 8, 10mm



GMA064

8pcs Glass drill bits set

Size: 5/32", 3/16", 1/4", 5/16", 3/8"



GMA065

333pcs Tools set

- 54pcs HSS titanium coated drill bits
- 72pcs HSS roll forged black finished drill bits
- 23pcs masonry drill bits
- 3pcs 12" length masonry drill bits
- 36pcs wood boring drill bits
- 5pcs flat wood drill bits
- 4pcs 12" length flat wood drill bits
- 5pcs hole saws
- 1pc hole saw mandrel
- 63pcs 1" screwdriver bits
- 1pc magnetic holder
- 38pcs 2" length screwdriver bits
- 12pcs nut drivers
- 6pcs drill stoppers
- 1pc hex key wrench
- 1pc drill gauge
- 1pc center pouch
- 3pcs cupped nail sets
- 4pcs plastic screw finders
- 1pc 1/2" counter sink



Carbon Steel Hole Saw

Art No.	Dia.mm	Dia.inch	Art No.	Dia.mm	Dia.inch	Art No.	Dia.mm	Dia.inch
GMB10001	19	3/4	GMB10011	41	1-5/8	GMB10021	73	2-7/8
GMB10002	22	7/8	GMB10012	44	1-3/4	GMB10022	76	3
GMB10003	25	1	GMB10013	48	1-7/8	GMB10023	79	3-1/8
GMB10004	28	1-3/32	GMB10014	51	2	GMB10024	83	3-1/4
GMB10005	29	1-1/8	GMB10015	54	2-1/8	GMB10025	88	3-1/2
GMB10006	30	1-3/16	GMB10016	57	2-1/4	GMB10026	89	3-1/2
GMB10007	32	1-1/4	GMB10017	60	2-3/8	GMB10027	95	3-3/4
GMB10008	35	1-3/8	GMB10018	64	2-1/2	GMB10028	102	4
GMB10009	38	1-1/2	GMB10019	67	2-5/8	GMB10029	127	5
GMB10010	39	1-17/32	GMB10020	70	2-3/4	GMB10030	152	6



Art No.	Shank Size	Drill Size	Fits Saws
GMB10031	3/8" hex	60 x 60mm	32-127mm 1-1/4"-5"

Art No.	Shank Size	Drill Size	Fits Saws
GMB10032	3/8" hex	60 x 60mm	32-127mm 1-1/4"-5"

Art No.	Shank Size	Drill Size	Fits Saws
GMB10033	1/4" hex	60 x 60mm	19-30mm 3/4"-3/16"

Art No.	Shank Size	Drill Size	Fits Saws
GMB10034	1/4" round	60 x 60mm	19-30mm 3/4"-3/16"

Art No.	Shank Size	Drill Size	Fits Saws
GMB10035	1/4" round	63.5 x 80mm	32-127mm 1-1/4"-5"

Art No.	Shank Size	Drill Size	Fits Saws
GMB10036	3/8" hex	60 x 60mm	32-127mm 1/4"-5"

Art No.	Drill Size
GMB10037	2.5mm fits any arbors

Art No.	Drill Size
GMB10038	Fits 3"-5-1/2"





Bi-metal Hole Saw



Art No.	Dia.mm	Dia.inch	Art No.	Dia.mm	Dia.inch	Art No.	Dia.mm	Dia.inch
GMB11001	13	1/2	GMB11039	51	2	GMB11077	98	3-7/8
GMB11002	14	9/16	GMB11040	52	2-1/16	GMB11078	100	3-15/16
GMB11003	15	19/32	GMB11041	53	2-3/32	GMB11079	102	4
GMB11004	16	5/8	GMB11042	54	2-1/8	GMB11080	105	4-1/8
GMB11005	17	11/16	GMB11043	55	2-11/64	GMB11081	108	4-1/4
GMB11006	18	11/16	GMB11044	56	2-13/64	GMB11082	111	4-3/8
GMB11007	19	3/4	GMB11045	57	2-1/4	GMB11083	114	4-1/2
GMB11008	20	25/32	GMB11046	58	2-9/32	GMB11084	117	4-39/64
GMB11009	21	13/16	GMB11047	59	2-5/16	GMB11085	121	4-3/4
GMB11010	22	7/8	GMB11048	60	2-3/8	GMB11086	124	4-7/8
GMB11011	23	29/32	GMB11049	61	2-13/32	GMB11087	127	5
GMB11012	24	15/16	GMB11050	62	2-7/16	GMB11088	130	5-1/8
GMB11013	25	1	GMB11051	63	2-31/64	GMB11089	133	5-1/4
GMB11014	26	1-1/32	GMB11052	64	2-1/2	GMB11090	138	5-7/16
GMB11015	27	1-1/16	GMB11053	65	2-9/16	GMB11091	140	5-1/2
GMB11016	28	1-3/32	GMB11054	66	2-19/32	GMB11092	145	5-45/64
GMB11017	29	1-1/8	GMB11055	67	2-5/8	GMB11093	146	5-3/4
GMB11018	30	1-3/16	GMB11056	68	2-11/16	GMB11094	148	5-53/64
GMB11019	31	1-7/32	GMB11057	69	2-23/32	GMB11095	151	5-15/16
GMB11020	32	1-1/4	GMB11058	70	2-3/4	GMB11096	152	6
GMB11021	33	1-5/16	GMB11059	71	2-51/64	GMB11097	160	6-19/64
GMB11022	34	1-11/32	GMB11060	72	2-53/64	GMB11098	165	6-1/2
GMB11023	35	1-3/8	GMB11061	73	2-7/8	GMB11099	168	6-5/8
GMB11024	36	1-27/64	GMB11062	74	2-58/64	GMB11100	172	6-49/64
GMB11025	37	1-7/16	GMB11063	75	2-61/64	GMB11101	175	6-59/64
GMB11026	38	1-1/2	GMB11064	76	3	GMB11102	176	6-31/32
GMB11027	39	1-17/32	GMB11065	77	3-1/32	GMB11103	177	7
GMB11028	40	1-9/16	GMB11066	78	3-5/64	GMB11104	178	7-3/32
GMB11029	41	1-5/8	GMB11067	79	3-1/8	GMB11105	180	7-9/32
GMB11030	42	1-21/32	GMB11068	80	3-5/32	GMB11106	185	7-13/32
GMB11031	43	1-11/16	GMB11069	83	3-1/4	GMB11107	188	7-31/64
GMB11032	44	1-3/4	GMB11070	85	3-11/32	GMB11108	190	7-7/8
GMB11033	45	1-49/64	GMB11071	86	3-3/8	GMB11109	200	8-17/64
GMB11034	46	1-13/16	GMB11072	87	3-27/64	GMB11110	210	8-15/32
GMB11035	47	1-27/32	GMB11073	89	3-1/2	GMB11111	215	8-15/32
GMB11036	48	1-7/8	GMB11074	90	3-35/64	GMB11112	220	8-21/32
GMB11037	49	1-15/16	GMB11075	92	3-5/8	GMB11113	225	8-55/64
GMB11038	50	1-31/32	GMB11076	95	3-3/4	GMB11114	230	9-1/6



Arbors

Art No.	Shank Size	Thread Size	Chunk Size	Fits Size
GMB11115	1/4 Round	1/2--20 UNF	1/4	9/16--1-3/16
GMB11116	3/8 Hex	1/2--20 UNF	3/8	9/16--1-3/16
GMB11117	7/16 Hex	1/2--20 UNF	1/2	9/16--1-3/16
GMB11118	7/16 Hex	5/8--18 UNF	1/2	1-1/4--8-17/64
GMB11119	3/8 Hex	5/8--18 UNF	3/8	1-1/4--8-17/64
GMB11120	5/8 Hex	5/8--18 UNF	3/4	1-1/4--8-17/64
GMB11121	SDS Plus	1/2--20 UNF	SDS	9/16--1-3/16
GMB11122	SDS Plus	5/8--18 UNF	SDS	1-1/4--8-17/64
GMB11123	SDS Plus	5/8--18 UNF	SDS	1-1/4--7-7/8



HSS Hole Saw

Art No.	Dia.mm	Art No.	Dia.mm	Art No.	Dia.mm
GMB12001	12	GMB12015	27	GMB12029	52
GMB12002	13	GMB12016	28	GMB12030	45
GMB12003	14	GMB12017	29	GMB12031	50
GMB12004	15	GMB12018	30	GMB12032	55
GMB12005	16	GMB12019	31	GMB12033	60
GMB12006	18	GMB12020	32	GMB12034	65
GMB12007	19	GMB12021	33	GMB12035	70
GMB12008	20	GMB12022	34	GMB12036	75
GMB12009	21	GMB12023	35	GMB12037	80
GMB12010	22	GMB12024	37	GMB12038	85
GMB12011	23	GMB12025	38	GMB12039	90
GMB12012	24	GMB12026	39	GMB12040	95
GMB12013	25	GMB12027	40	GMB12041	100
GMB12014	26	GMB12028	41		





Tungsten Carbide Coated Hole Saw

Art No.	Dia.mm
GMB13001	33
GMB13002	43
GMB13003	53
GMB13004	63
GMB13005	67
GMB13006	73
GMB13007	83
GMB13008	103
GMB13009	113



Base

Art No.	Size/mm
GMB13010	33-83
GMB13011	33-103
GMB13012	73-113

Center Drill

Art No.	Size
GMB13013	7.0 x 110mm

Tungsten Carbide Gritted Hole Saw

Art No.	Dia.mm	Dia.Inch	Art No.	Dia.mm	Dia.Inch
GMB14001	19	3/4	GMB14025	60	2-3/8
GMB14002	21	13/16	GMB14026	64	2-1/2
GMB14003	22	7/8	GMB14027	65	2-9/16
GMB14004	24	15/16	GMB14028	67	2-5/8
GMB14005	25	1	GMB14029	70	2-3/4
GMB14006	27	1-1/16	GMB14030	73	2-7/8
GMB14007	29	1-1/8	GMB14031	76	3
GMB14008	30	1-3/16	GMB14032	79	3-1/8
GMB14009	32	1-1/4	GMB14033	83	3-1/4
GMB14010	33	1-5/16	GMB14034	86	3-3/8
GMB14011	35	1-3/8	GMB14035	89	3-1/2
GMB14012	37	1-7/16	GMB14036	92	3-5/8
GMB14013	38	1-1/2	GMB14037	95	3-3/4
GMB14014	40	1-9/16	GMB14038	98	3-7/8
GMB14015	41	1-5/8	GMB14039	102	4
GMB14016	43	1-11/16	GMB14040	105	4-1/8
GMB14017	44	1-3/4	GMB14041	108	4-1/4
GMB14018	46	1-13/16	GMB14042	111	4-3/8
GMB14019	48	1-7/8	GMB14043	114	4-1/2
GMB14020	51	2	GMB14044	121	4-3/4
GMB14021	52	2-1/16	GMB14045	127	5
GMB14022	54	2-1/8	GMB14046	140	5-1/2
GMB14023	57	2-1/4	GMB14047	146	5-3/4
GMB14024	59	2-5/16	GMB14048	152	6

Art No.	Shank Size	Thread Size	Chunk Size	Fits Saws
GMB14049	3/8 Hex	1/2-20 UNF	3/8	3/4-1-3/16 (19-30mm)
GMB14050	7/16 Hex	5/8--18 UNF	1/2	1-1/4-6 (32-152mm)





TCT Hole Saw

Art No.	Dia.mm	Dia.Inch	Art No.	Dia.mm	Dia.Inch
GMB15001	12	15/32	GMB15018	40	1-9/16
GMB15002	13	1/2	GMB15019	42	1-21/32
GMB15003	14	9/16	GMB15020	45	1-25/32
GMB15004	15	19/32	GMB15021	48	1-7/8
GMB15005	16	5/8	GMB15022	50	1-31/32
GMB15006	17	11/16	GMB15023	52	2-1/32
GMB15007	19	3/4	GMB15024	55	2-5/32
GMB15008	20	25/32	GMB15025	58	2-9/32
GMB15009	21	13/16	GMB15026	60	2-3/8
GMB15010	22	7/8	GMB15027	65	2-9/16
GMB15011	24	15/16	GMB15028	70	2-3/4
GMB15012	25	1	GMB15029	75	2-15/16
GMB15013	28	1-3/32	GMB15030	80	3-3/32
GMB15014	30	1-3/16	GMB15031	85	3-13/32
GMB15015	32	1-11/32	GMB15032	90	3-17/32
GMB15016	35	1-3/8	GMB15033	95	3-3/4
GMB15017	38	1-1/2	GMB15034	100	4



Carbide Hole Saw

Art No.	Dia.mm	Dia.Inch	Art No.	Dia.mm	Dia.Inch
GMB16001	19	3/4	GMB16017	67	2-5/8
GMB16002	22	7/8	GMB16018	70	2-3/4
GMB16003	25	1	GMB16019	73	2-7/8
GMB16004	28	1-3/32	GMB16020	74	2-58/64
GMB16005	32	1-1/4	GMB16021	76	3
GMB16006	35	1-3/8	GMB16022	79	3-1/8
GMB16007	38	1-1/2	GMB16023	83	3-1/4
GMB16008	40	1-9/16	GMB16024	92	3-5/8
GMB16009	41	1-5/8	GMB16025	95	3-3/4
GMB16010	44	1-3/4	GMB16026	102	4
GMB16011	48	1-7/8	GMB16027	103	4-1/32
GMB16012	51	2	GMB16028	114	4-1/2
GMB16013	54	2-1/8	GMB16029	127	5
GMB16014	57	2-1/4	GMB16030	140	5-1/2
GMB16015	60	2-3/8	GMB16031	152	6
GMB16016	64	2-1/2			





T.C.T Hole Saw



Art No.	Dia.mm	Dia.Inch	Art No.	Dia.mm	Dia.Inch	Art No.	Dia.mm	Dia.Inch
GMB17001	14	9/16	GMB17025	49	1-15/16	GMB17049	73	2-7/8
GMB17002	15	19/32	GMB17026	50	1-31/32	GMB17050	74	2-58/64
GMB17003	16	5/8	GMB17027	51	2	GMB17051	75	2-61/64
GMB17004	17	11/16	GMB17028	52	2-1/16	GMB17052	76	3
GMB17005	18	11/16	GMB17029	53	2-3/32	GMB17053	77	3-1/32
GMB17006	19	3/4	GMB17030	54	2-1/8	GMB17054	78	3-5/64
GMB17007	20	25/32	GMB17031	55	2-11/64	GMB17055	79	3-1/8
GMB17008	21	13/16	GMB17032	56	2-13/64	GMB17056	80	3-5/32
GMB17009	22	7/8	GMB17033	57	2-1/4	GMB17057	83	3-1/4
GMB17010	23	29/32	GMB17034	58	2-9/32	GMB17058	85	3-11/32
GMB17011	24	15/16	GMB17035	59	2-5/16	GMB17059	86	3-3/8
GMB17012	25	1	GMB17036	60	2-3/8	GMB17060	87	3-27/64
GMB17013	26	1-1/32	GMB17037	61	2-13/32	GMB17061	89	3-1/2
GMB17014	27	1-1/16	GMB17038	62	2-7/16	GMB17062	90	3-35/64
GMB17015	28	1-1/8	GMB17039	63	2-31/64	GMB17063	92	3-5/8
GMB17016	29	1-1/8	GMB17040	64	2-1/2	GMB17064	95	3-3/4
GMB17017	30	1-3/16	GMB17041	65	2-9/16	GMB17065	98	3-7/8
GMB17018	32	1-1/4	GMB17042	66	2-19/32	GMB17066	100	3-15/16
GMB17019	35	1-3/8	GMB17043	67	2-5/8			
GMB17020	38	1-1/2	GMB17044	68	2-11/16			
GMB17021	40	1-9/16	GMB17045	69	2-23/32			
GMB17022	42	1-31/32	GMB17046	70	2-3/4			
GMB17023	45	1-49/64	GMB17047	71	2-51/64			
GMB17024	48	1-7/8	GMB17048	72	2-53/64			

Hole Saw for Concrete

Art No.	Dia.mm	L1 Oal
GMB18001	30.0	72
GMB18002	32.0	72
GMB18003	35.0	72
GMB18004	40.0	72
GMB18005	45.0	72
GMB18006	50.0	72
GMB18007	55.0	72
GMB18008	60.0	72
GMB18009	65.0	72
GMB18010	70.0	72
GMB18011	75.0	72
GMB18012	80.0	72
GMB18013	90.0	72
GMB18014	100.0	72
GMB18015	105.0	72
GMB18016	110.0	72
GMB18017	120.0	72

Remark: long series available.





Diamond Grit Edged Hole Saw



Art No.	Dia.mm	Dia.Inch	Art No.	Dia.mm	Dia.Inch	Art No.	Dia.mm	Dia.Inch
GMB19001	13	1/2	GMB19039	51	2	GMB19077	98	3-7/8
GMB19002	14	9/16	GMB19040	52	2-1/16	GMB19078	100	3-15/16
GMB19003	15	19/32	GMB19041	53	2-3/32	GMB19079	101	3-31/32
GMB19004	16	5/8	GMB19042	54	2-1/8	GMB19080	102	4
GMB19005	17	11/16	GMB19043	55	2-11/64	GMB19081	103	4-1/32
GMB19006	18	11/16	GMB19044	56	2-13/64	GMB19082	104	4-1/16
GMB19007	19	3/4	GMB19045	57	2-1/4	GMB19083	105	4-3/32
GMB19008	20	25/32	GMB19046	58	2-9/32	GMB19084	107	4-1/8
GMB19009	21	13/16	GMB19047	59	2-5/16	GMB19085	108	4-1/4
GMB19010	22	7/8	GMB19048	60	2-3/8	GMB19086	110	4-5/16
GMB19011	23	29/32	GMB19049	61	2-13/32	GMB19087	111	4-3/8
GMB19012	24	15/16	GMB19050	62	2-7/16	GMB19088	112	4-27/64
GMB19013	25	1	GMB19051	63	2-31/64	GMB19089	113	4-7/16
GMB19014	26	1-1/32	GMB19052	64	2-1/2	GMB19090	114	4-1/2
GMB19015	27	1-1/16	GMB19053	65	2-9/16	GMB19091	115	4-17/32
GMB19016	28	1-3/32	GMB19054	66	2-19/32	GMB19092	116	4-9/16
GMB19017	29	1-1/8	GMB19055	67	2-5/8	GMB19093	117	4-39/64
GMB19018	30	1-3/16	GMB19056	68	2-11/16	GMB19094	118	4-5/8
GMB19019	31	1-7/32	GMB19057	69	2-23/32	GMB19095	119	4-21/32
GMB19020	32	1-1/4	GMB19058	70	2-3/4	GMB19096	120	4-11/16
GMB19021	33	1-5/16	GMB19059	71	2-51/64	GMB19097	121	4-3/4
GMB19022	34	1-11/32	GMB19060	72	2-53/64	GMB19098	122	4-49/64
GMB19023	35	1-3/8	GMB19061	73	2-7/8	GMB19099	123	4-13/16
GMB19024	36	1-27/64	GMB19062	74	2-58/64	GMB19100	124	4-7/8
GMB19025	37	1-7/16	GMB19063	75	2-61/64	GMB19101	125	4-15/16
GMB19026	38	1-1/2	GMB19064	76	3	GMB19102	126	4-31/32
GMB19027	39	1-17/32	GMB19065	77	3-1/32	GMB19103	127	5
GMB19028	40	1-9/16	GMB19066	78	3-5/64	GMB19104	128	5-1/32
GMB19029	41	1-5/8	GMB19067	79	3-1/8	GMB19105	129	5-1/16
GMB19030	42	1-21/32	GMB19068	80	3-5/32	GMB19106	130	5-1/8
GMB19031	43	1-11/16	GMB19069	83	3-1/4	GMB19107	133	5-1/4
GMB19032	44	1-3/4	GMB19070	85	3-11/32	GMB19108	138	5-7/16
GMB19033	45	1-49/64	GMB19071	86	3-3/8	GMB19109	140	5-1/2
GMB19034	46	1-13/16	GMB19072	87	3-27/64	GMB19110	145	5-45/64
GMB19035	47	1-27/32	GMB19073	89	3-1/2	GMB19111	146	5-3/4
GMB19036	48	1-7/8	GMB19074	90	3-35/64	GMB19112	148	5-53/64
GMB19037	49	1-15/16	GMB19075	92	3-5/8	GMB19113	151	5-15/16
GMB19038	50	1-31/32	GMB19076	95	3-3/4	GMB19114	152	6

**Circular Saw Blade For Wood Working**

Art No.	Outer		Body Thickness(mm)	Hole Diameter(mm)	Segment Number
	Inches	Metric(mm)			
GMC10001	4-1/4"	110	1.2	20	24T
GMC10002	4-1/4"	110	1.2	20	30T
GMC10003	5"	125	1.2	20	24T
GMC10004	5"	125	1.2	20	30T
GMC10005	5-1/2"	140	1.4	20	24T
GMC10006	5-1/2"	140	1.4	20	30T
GMC10007	6"	150	1.4	20	24T
GMC10008	6"	150	1.4	20	30T
GMC10009	6-1/4"	160	1.4	20	24T
GMC10010	6-1/4"	160	1.4	20	40T
GMC10011	7"	180	1.4	25.4	40T
GMC10012	7"	180	1.4	25.4	60T
GMC10013	7-1/4"	185	1.4	25.4	24T
GMC10014	7-1/4"	185	1.4	25.4	40T
GMC10015	7-1/2"	190	1.4	25.4	40T
GMC10016	7-1/2"	190	1.4	25.4	60T
GMC10017	8"	200	1.4	25.4	40T
GMC10018	8"	200	1.4	25.4	60T
GMC10019	8-1/4"	210	1.4	25.4	40T
GMC10020	8-1/4"	210	1.4	25.4	60T
GMC10021	9"	230	1.6	25.4	40T
GMC10022	9"	230	1.6	25.4	60T
GMC10023	10"	250	1.8	25.4	40T
GMC10024	10"	250	1.8	25.4	60T
GMC10025	10"	250	1.8	25.4	80T
GMC10026	12"	300	2.0	30	80T
GMC10027	12"	300	2.0	30	100T
GMC10028	13"	330	2.0	30	100T
GMC10029	14"	350	2.2	30	80T
GMC10030	14"	350	2.2	30	100T
GMC10031	16"	400	2.2	30	80T
GMC10032	16"	400	2.2	30	120T



General Purpose TCT Saw Blade (Cutting Aluminum/Wood)

Art No.	Outer		Body Thickness(mm)	Hole Diameter(mm)	Segment Number
	Inches	Metric(mm)			
GMC11001	4-1/4"	110	1.2	20	30T
GMC11002	4-1/4"	110	1.2	20	40T
GMC11003	5"	125	1.2	20	30T
GMC11004	5"	125	1.2	20	40T
GMC11005	5-1/2"	140	1.4	20	30T
GMC11006	5-1/2"	140	1.4	20	40T
GMC11007	6"	150	1.4	20	30T
GMC11008	6"	150	1.4	20	40T
GMC11009	6-1/4"	160	1.4	20	40T
GMC11010	6-1/4"	160	1.4	20	60T
GMC11011	7"	180	1.4	25.4	40T
GMC11012	7"	180	1.4	25.4	60T
GMC11013	7-1/4"	185	1.4	25.4	40T
GMC11014	7-1/4"	185	1.4	25.4	60T
GMC11015	7-1/2"	190	1.4	25.4	80T
GMC11016	7-1/2"	190	1.4	25.4	60T
GMC11017	8"	200	1.4	25.4	80T
GMC11018	8"	200	1.4	25.4	60T
GMC11019	8-1/4"	210	1.4	25.4	80T
GMC11020	8-1/4"	210	1.4	25.4	60T
GMC11021	9"	230	1.6	25.4	80T
GMC11022	9"	230	1.6	25.4	100T
GMC11023	10"	250	1.8	25.4	80T
GMC11024	10"	250	1.8	25.4	100T
GMC11025	10"	250	1.8	25.4	120T
GMC11026	12"	300	2.0	30	80T
GMC11027	12"	300	2.0	30	100T
GMC11028	13"	330	2.0	30	100T
GMC11029	14"	350	2.2	30	80T
GMC11030	14"	350	2.2	30	100T
GMC11031	16"	400	2.2	30	80T
GMC11032	16"	400	2.2	30	120T
GMC11033	18"	450	2.5	30	120T



T.C.T Saw Blade For Cutting Steel/Soft Plastic

Art No.	Outer		Body Thickness(mm)	Hole Diameter(mm)	Segment Number
	Inches	Metric(mm)			
GMC12001	4-1/4"	110	1.4	20	24T
GMC12002	5"	125	1.4	20	24T
GMC12003	5-1/2"	140	1.4	20	24T
GMC12004	6"	150	1.5	25.4	24T
GMC12005	6-1/4"	160	1.5	25.4	30T
GMC12006	7"	180	1.5	25.4	40T
GMC12007	7-1/2"	190	1.5	25.4	40T
GMC12008	8"	200	1.6	25.4	40T
GMC12009	8-1/4"	210	1.6	25.4	40T
GMC12010	8-1/4"	210	1.6	25.4	80T
GMC12011	9"	230	1.7	25.4	80T
GMC12012	9"	230	1.7	25.4	80T
GMC12013	10"	250	1.8	25.4	80T
GMC12014	10"	250	1.8	25.4	80T
GMC12015	12"	300	2.0	30	80T
GMC12016	12"	300	2.0	31	100T
GMC12017	14"	350	2.2	32	100T
GMC12018	14"	350	2.2	33	120T
GMC12019	16"	400	2.2	34	100T
GMC12020	16"	400	2.2	35	120T
GMC12021	18"	450	3.0	36	100T
GMC12022	18"	450	3.0	37	120T
GMC12023	20"	500	3.0	38	100T
GMC12024	20"	500	3.0	39	140T





T.C.T Saw Blade For Grass

Art No.	Outer		Inner		Teeth No.
	Inch	Metric(mm)	Inch	Metric(mm)	
GMC13001	9"	230	7/8",1",1-1/5"	22/25.4/30	30-60T
GMC13002	10"	250	7/8",1",1-1/5"	22/25.4/30	30-60T

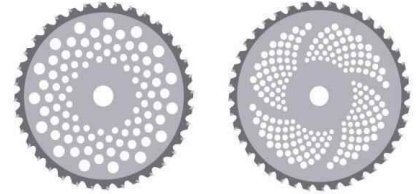

**Diamond Saw Blade
Segmented Blade**

DRY

Art No.	Outer		Arbor Size(mm)	Segment Diameter(mm)	Segment Number
	Inch	Metric(mm)			
GMC14001	4"	105	16/20/22.23	35*1.8*7/10	8/9/16T
GMC14002	4.3"	110	16/20/22.23	32*1.9*7/10	8/9/12/16T
GMC14003	4.5"	115	20/22.23	38*2.0*7/10	8T
GMC14004	5"	125	20/22.23	37*2.0*7/10	9T
GMC14005	6"	150	20/22.23	34*2.0*7/10	12T
GMC14006	7"	180	22.23/25.4	35*2.2*7/10	14T
GMC14007	8"	200	22.23/25.4	39*2.4*7/10	14T
GMC14008	9"	230	22.23/25.4	34*2.4*7.2/10	16/18T
GMC14009	10"	250	22.23/25.4	37*3.0*7.5/10	18T
GMC14010	12"	300	20/22.23/25.4/50	35*3.2*7.5/10	22T
GMC14011	14"	350	22.23/25.4/50	40*3.2*7.5/10	24T
GMC14012	16"	400	22.23/25.4/50	40*3.6*7.5/10	28T

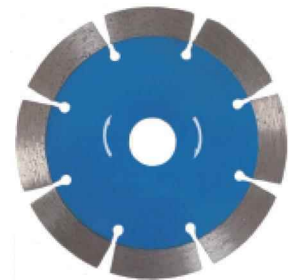

Continuous Rim Blade

WET

Art No.	Outer		Arbor Size(mm)	Segment Diameter(mm)
	Inch	Metric(mm)		
GMC15001	4"	105	16/20/22.23	1.8*5/7/10
GMC15002	4.3"	110	16/20/22.23	1.9*5/7/10
GMC15003	4.5"	115	20/22.23	1.9*5/7/10
GMC15004	5"	125	20/22.23	1.9*5/7/10
GMC15005	6"	150	20/22.23	1.9*5/7/10
GMC15006	7"	180	22.23/25.4	2.2*5/7/10
GMC15007	8"	200	22.23/25.4	2.4*5/7/10
GMC15008	9"	230	22.23/25.4	2.6*5/7/10
GMC15009	10"	250	22.23/25.4	3.0*5/7/10
GMC15010	12"	300	20/22.23/25.4/50	3.2*7/10
GMC15011	14"	350	22.23/25.4/50	3.2*7.5/10
GMC15012	16"	400	22.23/25.4/50	3.4*7.5/10



Turbo Blade

Continuous Rim Blade

Wet Dry

Art No.	Outer		Arbor Size(mm)	Segment Diameter(mm)
	Inch	Metric(mm)		
GMC16001	4"	105	16/20/22.23	2.0*8/10
GMC16002	4.3"	110	16/20/22.23	2.0*8/10
GMC16003	4.5"	115	20/22.23	2.2*8/10
GMC16004	5"	125	20/22.23	2.2*8/10
GMC16005	6"	150	20/22.23	2.4*8/10
GMC16006	7"	180	22.23/25.4	2.6*8/10
GMC16007	8"	200	22.23/25.4	2.6*8/10
GMC16008	9"	230	22.23/25.4	3.0*7.5/10
GMC16009	10"	250	22.23/25.4	3.1*8/10
GMC16010	12"	300	20/22.23/25.4/50	3.2*8/10
GMC16011	14"	350	22.23/25.4/50	3.2*8/10
GMC16012	16"	400	22.23/25.4/50	3.8*8/10

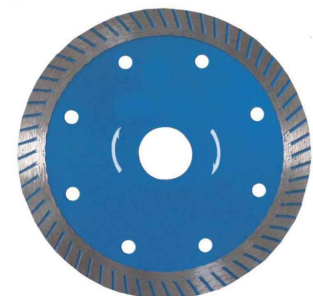



Turbo Wave Blade



Wet Dry

Art No.	Outer		Arbor Size(mm)	Segment Diameter(mm)
	Inch	Metric(mm)		
GMC17001	4"	105	16/20/22.23	2.5*8
GMC17002	4.3"	110	16/20/22.23	2.5*8/10
GMC17003	4.5"	115	20/22.23	2.5*8/10
GMC17004	5"	125	20/22.23	2.5*8
GMC17005	6"	150	20/22.23	2.5*8
GMC17006	7"	180	22.23/25.4	2.8*8/10
GMC17007	8"	200	22.23/25.4	3.0*9
GMC17008	9"	230	22.23/25.4	3.1*8/10
GMC17009	10"	250	22.23/25.4	3.4*10
GMC17010	12"	300	20/22.23/25.4/50	3.6*8/10

HSS Circular Saw Blade



Art No.	Out Dia.(mm)	Plate Thick(mm)	Hole Dia.(mm)	No. of Teeth(T)
GMC18001	225	2.0	40	120
GMC18002	225	2.0	32	180
GMC18003	250	2.0	32	128
GMC18004	250	2.0	32	160
GMC18005	250	2.0	32	180
GMC18006	250	2.0	32	200
GMC18007	250	2.5	32	160
GMC18008	250	2.5	32	200
GMC18009	275	2.5	32	140
GMC18010	275	2.5	32	180
GMC18011	275	2.5	32	220
GMC18012	275	2.5	40	220
GMC18013	300	2.5	32	160
GMC18014	300	2.5	32	220
GMC18015	315	2.5	32	160
GMC18016	315	2.5	32	200
GMC18017	315	2.5	40	200
GMC18018	315	2.5	32	240
GMC18019	350	2.5	32	180



Diamond Blade



Art No.: GMC19001



Art No.: GMC19002



Art No.: GMC19003



Art No.: GMC19004



Art No.: GMC19005



Art No.: GMC19006



Art No.: GMC19007

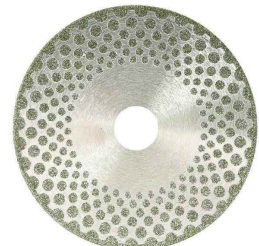

Art No.: GMC19008



Art No.: GMC19009

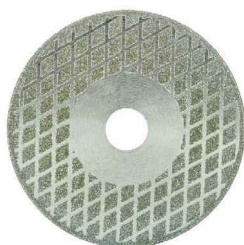

Art No.: GMC19010



Art No.: GMC19011



Art No.: GMC19012



Cut-off Wheels For Metal

Art No.	Size(mm)	Inch	Pcs/ctn	Art No.	Size(mm)	Inch
GMC20001	105x2x16	4x1/12x5/8	600	GMC20009	180x2x22	7x1/12x7/8
GMC20002	100x3x16	4x1/8x5/8	400	GMC20010	180x3x22	7x1/8x7/8
GMC20003	115x2x22	4.5x1/12x7/8	400	GMC20011	230x3x22	9x1/8x7/8
GMC20004	115x3x22	4.5x1/8x7/8	200	GMC20012	255x3x25.4	10x1/8x1
GMC20005	125x2x22	5x1/12x7/8	400	GMC20013	305x3x25.4	12x1/8x1
GMC20006	125x3x22	5x1/8x7/8	200	GMC20014	355x3x25.4	14x1/8x1
GMC20007	150x2x22	6x1/12x7/8	280	GMC20015	400x3x25.4/32	16x1/8x1
GMC20008	150x3x22	6x1/8x7/8	100	GMC20016	400x3x32	16x1/8x1-1/4

Type41



Cut-off Wheels For Stone

Art No.	Size(mm)	Inch	Pcs/ctn	Art No.	Size(mm)	Inch
GMC21001	105x2x16	4x1/12x5/8	600	GMC21009	180x2x22	7x1/12x7/8
GMC21002	100x3x16	4x1/8x5/8	400	GMC21010	180x3x22	7x1/8x7/8
GMC21003	115x2x22	4.5x1/12x7/8	400	GMC21011	230x3x22	9x1/8x7/8
GMC21004	115x3x22	4.5x1/8x7/8	200	GMC21012	255x3x25.4	10x1/8x1
GMC21005	125x2x22	5x1/12x7/8	400	GMC21013	305x3x25.4	12x1/8x1
GMC21006	125x3x22	5x1/8x7/8	200	GMC21014	355x3x25.4	14x1/8x1
GMC21007	150x2x22	5x1/12x7/8	280	GMC21015	400x3x25.4/32	16x1/8x1
GMC21008	150x3x22	6x1/8x7/8	100	GMC21016	400x3x32	16x1/8x1-1/4

Type41



Depressed Center Cut-off Wheels For Metal

Art No.	Dimension mm	Speed r.p.m
GMC22001	100x2.5x16	15200
GMC22002	100x3.0x16	15200
GMC22003	115x2.5x22	13300
GMC22004	115x3.0x22	13300
GMC22005	125x2.5x22	12200
GMC22006	125x3.0x22	12200
GMC22007	180x2.5x22	8500
GMC22008	180x3.0x22	8500
GMC22009	230x2.5x22	6600
GMC22010	230x3.0x22	6600

Type42



Depressed Center Cut-off Wheels For Stone

Art No.	Dimension mm	Speed r.p.m
GMC23001	100x2.5x16	15200
GMC23002	100x3.0x16	15200
GMC23003	115x2.5x22	13300
GMC23004	115x3.0x22	13300
GMC23005	125x2.5x22	12200
GMC23006	125x3.0x22	12200
GMC23007	180x2.5x22	8500
GMC23008	180x3.0x22	8500
GMC23009	230x2.5x22	6600
GMC23010	230x3.0x22	6600

Type42





Grinding Wheels For Metal

Art No.	Dimension mm	Speed r.p.m
GMC24001	100x4.0x16	15200
GMC24002	100x6.0x16	15200
GMC24003	115x4.0x22	13300
GMC24004	115x6.0x22	13300
GMC24005	125x4.0x22	12200
GMC24006	125x6.0x22	12200
GMC24007	150x4.0x22	10200
GMC24008	150x6.0x22	10200
GMC24009	180x6.0x22	8500
GMC24010	180x8.0x22	8500
GMC24011	230x6.0x22	6600
GMC24012	230x8.0x22	6600

Grinding Wheels For Stone

Art No.	Dimension mm	Speed r.p.m
GMC25001	100x4.0x16	15200
GMC25002	100x6.0x16	15200
GMC25003	115x4.0x22	13300
GMC25004	115x6.0x22	13300
GMC25005	125x4.0x22	12200
GMC25006	125x6.0x22	12200
GMC25007	150x4.0x22	10200
GMC25008	150x6.0x22	10200
GMC25009	180x6.0x22	8500
GMC25010	180x8.0x22	8500
GMC25011	230x6.0x22	6600
GMC25012	230x8.0x22	6600

Type27



Type27



Cut-off Wheels For Stainless Steel

Art No.	Dimension mm	Speed r.p.m
GMC26001	100x1.2x16	15200
GMC26002	100x1.6x16	15200
GMC26003	115x1.2x22	13300
GMC26004	115x1.6x22	13300
GMC26005	125x1.2x22	12200
GMC26006	125x1.6x22	12200
GMC26007	180x2.0x22	8500
GMC26008	230x2.0x22	6600

Grinding Wheels For Stainless Steel

Art No.	Dimension mm	Speed r.p.m
GMC27001	100x4.0x16	15200
GMC27002	100x6.0x16	15200
GMC27003	115x4.0x22	13300
GMC27004	115x6.0x22	13300
GMC27005	125x4.0x22	12200
GMC27006	125x6.0x22	12200
GMC27007	150x4.0x22	10200
GMC27008	150x6.0x22	10200
GMC27009	180x6.0x22	8500
GMC27010	180x8.0x22	8500
GMC27011	230x6.0x22	6600
GMC27012	230x8.0x22	6600

Type41



Type27





Reciprocating Saw Blade

Art No.	Specification	Teeth	Material	Note
GMD10001	6" 152*19*1.2	6TPI	HCS	S644D
GMD10002	9" 228*19*1.2	3TPI	HCS	S1111K
GMD10003	240*19*1.5	5TPI	HCS	S1531L
GMD10004	240*19*1.5	3TPI	HCS	S1542K
GMD10005	6" 150*19*0.9	24TPI	BIM	S922AF
GMD10006	6" 150*19*0.9	18TPI	BIM	S922EF
GMD10007	6" 150*19*0.9	14TPI	BIM	S922BF
GMD10008	6" 150*19*0.9	10TPI	BIM	S922HF
GMD10009	6" 150*19*0.9	10-14TPI	BIM	S922VF
GMD10010	9" 228*19*0.9	18TPI	BIM	S1122EF
GMD10011	9" 228*19*0.9	14TPI	BIM	S1122BF
GMD10012	9" 228*19*0.9	10TPI	BIM	S1122HF
GMD10013	9" 228*19*1.27	6TPI	BIM	S1111DF
GMD10014	12" 300*19*1.27	6TPI	BIM	S1411DF
GMD10015	12" 300*19*1.27	10-14TPI	BIM	S1222VF

Jig Saw Blade

Art No.	Specification	Teeth	Material	Note
GMD11001	100*9*1.2	8TPI	HCS	T111C
GMD11002	100*8*1.2	6TPI	HCS	T111D
GMD11003	100*8*1.5	10TPI	HCS	T101B
GMD11004	100*8*1.5	10TPI	HCS	T101BR
GMD11005	100*8*1.5	6TPI	HCS	T101D
GMD11006	75*5*1.2	18TPI	HCS	T101AO
GMD11007	100*8*1.2	6TPI	HCS	T144D
GMD11008	100*6*1.2	6TPI	HCS	T244D
GMD11009	75*8*1.0	21TPI	HSS	T118A
GMD11010	75*8*1.0	12TPI	HSS	T118B
GMD11011	100*8*1.0	8TPI	HSS	T127D
GMD11012	100*6*1.0	8TPI	HSS	T227D
GMD11013	75*5*1.0	12TPI	HCS	T119BO
GMD11014	75*8*1.2	12TPI	HCS	T119B
GMD11015	75*8*0.9	21TPI	BIM	T118AF
GMD11016	75*8*0.9	12TPI	BIM	T118BF
GMD11017	115*8*1.5	8TPI	HCS	T301CD
GMD11018	132*8*1.5	6TPI	HCS	T301DL
GMD11019	100*9*1.0	progressive	HSS	T123X
GMD11020	100*8*1.5	10TPI	BIM	T101BF
GMD11021	100*8*1.2	6TPI	BIM	T144DF
GMD11022	100*9*1.2	8TPI	HCS	U111C
GMD11023	100*8*1.5	10TPI	HCS	U101B
GMD11024	100*8*1.2	6TPI	HCS	U144D
GMD11025	75*8*1.2	12TPI	HCS	U119B
GMD11026	75*5*1.0	12TPI	HCS	U119BO



Hacksaw Blade

Art No.	L.	Teeth	Material
GMD12001	12"	18TPI	HSS
GMD12002	12"	24TPI	HSS
GMD12003	12"	32TPI	HSS
GMD12004	12"	18TPI	BIM
GMD12005	12"	24TPI	BIM
GMD12006	12"	32TPI	BIM
GMD12007	12"	18TPI	HCS
GMD12008	12"	24TPI	HCS
GMD12009	12"	32TPI	HCS





Cylinder Boring Bits. Similar DIN7483-G

Art No.	Dia.	Shk. DxL2	L1 Oal.
GME12001	8.0	8x30	90
GME12002	10.0	8x30	90
GME12003	12.0	8x30	90
GME12004	14.0	8x30	90
GME12005	15.0	8x30	90
GME12006	16.0	8x30	90
GME12007	18.0	8x30	90
GME12008	20.0	8x30	90
GME12009	22.0	8x30	90
GME12010	24.0	8x30	90
GME12011	25.0	8x30	90
GME12012	26.0	8x30	90
GME12013	28.0	8x30	90
GME12014	30.0	8x30	90
GME12015	32.0	10x30	90
GME12016	34.0	10x30	90
GME12017	35.0	10x30	90
GME12018	36.0	10x30	90
GME12019	38.0	10x30	90
GME12020	40.0	10x30	90
GME12021	42.0	10x30	90
GME12022	45.0	10x30	90
GME12023	48.0	10x30	90
GME12024	50.0	10x30	90



**TCT-Cylinder Boring Bits
(Carbide Tipped)**

Art No.	Dia.	Shk. DxL2	L1 Oal.
GME12025	30.0	8x30	90
GME12026	32.0	10x30	90
GME12027	34.0	10x30	90
GME12028	35.0	10x30	90
GME12029	36.0	10x30	90
GME12030	38.0	10x30	90
GME12031	40.0	10x30	90
GME12032	45.0	10x30	90
GME12033	50.0	10x30	90



Long Forstner Bits With Tooth

Art No.	Metric	Inch
GME13001	10x9.5x150	3/8x3/8x6
GME13002	12x9.5x150	1/2x3/8x6
GME13003	15x9.5x150	9/16x3/8x6
GME13004	16x9.5x150	5/8x3/8x6
GME13005	20x9.5x150	3/4x3/8x6
GME13006	22x9.5x150	7/8x3/8x6
GME13007	25x9.5x150	1x3/8x6
GME13008	27x9.5x150	1-1/16x3/8x6
GME13009	30x9.5x150	1-1/4x3/8x6
GME13010	35x9.5x150	1-3/8x3/8x6
GME13011	40x9.5x150	1-5/8x3/8x6
GME13012	43x9.5x150	1-11/16x3/8x6
GME13013	45x9.5x150	1-3/4x3/8x6
GME13014	50x9.5x150	2x3/8x6
GME13015	60x13.0x160	2-3/8x1/2x6-3/8
GME13016	80x13.0x160	3-1/8x1/2x6-3/8
GME13017	83x13.0x160	3-1/4x1/2x6-3/8





Forstner Bits With Auger

Art No.	Dia.mm	Dia.Inch
GME13018	25.0	1
GME13019	28.0	1-1/8
GME13020	32.0	1-1/4
GME13021	35.0	1-3/8
GME13022	38.0	1-1/2
GME13023	45.0	1-3/4
GME13024	51.0	1/2
GME13025	54.0	2-1/8
GME13026	57.0	2-1/4
GME13027	65.0	2-9/16
GME13028	76.0	3
GME13029	92.0	3-5/8
GME13030	117.0	4-5/8



DIN6446B Countersink

Art No.	Dia.	For drill
GME15001	10.0	3.0
GME15002	13.0	4.0
GME15003	16.0	5.0
GME15004	20.0	6.0

Hex Shank Forstner Bits

mm

Art No.	Dia	Shank DxL2	L1 Oal.
GME14002	6.0	6x30	90
GME14003	8.0	6x30	90
GME14004	10.0	8x30	90
GME14005	11.0	8x30	90
GME14006	12.0	8x30	90
GME14007	14.0	8x30	90
GME14008	15.0	8x30	90
GME14009	16.0	8x30	90
GME14010	18.0	8x30	90
GME14011	20.0	8x30	90
GME14012	21.0	8x30	90
GME14013	22.0	8x30	90
GME14014	24.0	8x30	90
GME14015	25.0	8x30	90



Hex Shank Forstner Bits

Art No.	Dia	Shank	L1 Oal.
GME14017	1/4	3/8	3-5/32
GME14018	3/8	3/8	3-5/32
GME14019	1/2	3/8	3-5/32
GME14020	5/8	3/8	3-5/32
GME14021	3/4	3/8	3-5/32
GME14022	7/8	3/8	3-5/32
GME14023	1	3/8	3-5/32

Hinge Drills

Art No.	Dia.	
GME16001	2.0mm	5/64
GME16002	2.5mm	3/32
GME16003	2.8mm	7/64
GME16004	3.2mm	1/8



GME001

4pcs Router bits set

- Cove bit: S*R1/8
- Cove bit: S*R1/4
- Cove bit: S*R3/8
- Cove bit: S*R1/2



GME002

5pcs Router bits set

- Stile&rail set-roman ogee bit: 1/2*1-3/4
- 15° lock miter bit: 1/2*1-1/2
- Raised panel bit: 1/2*1-1/2
- Stile&rail set-round bit: 1/2*3/8-a
- Stile&rail set-round bit: 1/2*3/8-b



GME003

5pcs Router bits set

- Cove box bit: S*R3/16
- Dovetail bit: S*1/2
- Bearing flush trim bit: S*1/2
- Rounding over bit: S*R1/4
- Straight bit (single flute): S*R1/4



GME004

6pcs Router bits set

- Cove bit: S*R6.3mm
- Straight bit: S*6mm
- Rounding over bit: S*R6.3mm
- Bearing flush trim bit: S*12.7mm
- Straight bit: S*12mm
- Dovetail bit: S*12.7mm



GME005

6pcs Router bits set

- 3° flush trim bit: 1/2*3/4*2
- Raised panel bit: 1/2*3/4
- Curved line bit: 1/2*1
- Stile&rail set-roman ogee bit: 1/2*7/16-a
- Stile&rail set-roman ogee bit: 1/2*7/16-b
- Raised panel bit with back cutter bit: 1/2*1-1/2



GME006

6pcs Router bits set

- Rounding over bit: S*R3mm
- Rounding over bit: S*R4mm
- Rounding over bit: S*R5mm
- Rounding over bit: S*R6mm
- Rounding over bit: S*R8mm
- Rounding over bit: S*R10mm



GME007

12pcs Router bits set

- Straight bit: S*6mm
- Straight bit: S*6mm
- Straight bit: S*16mm
- 90° grooving bit: S*12.7mm
- Dovetail bit: S*12.7mm
- 45° chamfer bit: S*32mm
- Bearing flush trim bit: S*12.7mm
- Rounding over bit: S*R6.3mm
- Rounding over bit: S*R6.3mm
- Cove box bit: S* R6.3mm
- Cove bit: S* R6.3mm
- Roman ogee bit: S*R4mm



GME008

12pcs Router bits set

- Cleaning bottom bit: S*8mm
- Cleaning bottom bit: S*16mm
- Bearing flush trim bit: S*13mm
- Cove box bit: S*R6mm
- Dovetail bit: S*14.3mm
- 60° "V" grooving bit: S*15mm
- 45° chamfer bit: S*27mm
- Rounding over bit: S*R6mm
- Cove bit: S*R6mm
- Rounding over bit: S*R10mm
- Cove bit: S* R10mm
- Roman ogee bit: S*R6.4mm



GME009

24pcs Router bits set

- Mortising bit: S*1/2
- Combination bevel bit: S*1/2
- Dovetail bit: S*3/8
- Dovetail bit: S*1/2
- 90° grooving bit: S*1/2
- Round nose bit: S*3/8
- Round nose bit: S*1/2
- Trimming bit: S*3/8
- Panel pilot bit: S*1/4
- Straight bit: S*1/4
- Straight bit: S*3/8
- Straight bit: S*1/2
- Straight bit: S*3/4
- Bearing flush trim bit: S*1/2
- Rounding over bit: S*R1/8
- Rounding over bit: S*R3/16
- Rounding over bit: S*R1/4
- Rounding over bit: S*R3/8
- Cover bit: S*R3/8
- Cove bit: S*R1/4
- 45° chamfer bit: S*R1/2
- Roman ogee bit: S*R5/32
- Slot cutter bit: S*1/4
- Rabbeting bit: S*1/2

**DIN352 Hand Tap**

Art No.	Code	P	d1	d2	d3 (h13)	L1	L2	a (h12)	L
GMF10001	M1	0.25	1	2.5	d1-0.3	32	5.5	2.1	5
GMF10002	M1.1	0.25	1.1	2.5	d1-0.3	32	5.5	2.1	5
GMF10003	M1.2	0.25	1.2	2.5	d1-0.3	32	5.5	2.1	5
GMF10004	M1.4	0.3	1.4	2.5	d1-0.4	32	7	2.1	5
GMF10005	M1.6	0.35	1.6	2.5	d1-0.4	32	8	2.1	5
GMF10006	M1.7	0.35	1.7	2.5	d1-0.4	32	8	2.1	5
GMF10007	M1.8	0.35	1.8	2.5	d1-0.4	32	8	2.1	5
GMF10008	M2	0.4	2	2.8	d1-0.5	36	8	2.1	5
GMF10009	M2.2	0.45	2.2	2.8	d1-0.6	36	9	2.1	5
GMF10010	M2.3	0.4	2.3	2.8	d1-0.5	36	9	2.1	5
GMF10011	M2.5	0.45	2.5	2.8	d1-0.6	40	9	2.1	5
GMF10012	M2.6	0.45	2.6	2.8	d1-0.6	40	9	2.1	5
GMF10013	M3	0.5	3	3.5	d1-0.6	40	11	2.7	6
GMF10014	M3.5	0.6	3.5	4	d1-0.7	45	13	3	6
GMF10015	M4	0.7	4	4.5	d1-0.8	45	13	3.4	6
GMF10016	M4.5	0.75	4.5	6	d1-0.9	50	16	4.9	8
GMF10017	M5	0.8	5	6	d1-1	50	16	4.9	8
GMF10018	M6	1	6	6	d1-1.2	50	19	4.9	8
GMF10019	M7	1	7	6	d1-1.2	50	19	4.9	8
GMF10020	M8	1.25	8	6	d1-1.5	56	22	4.9	8
GMF10021	M9	1.25	9	7	d1-1.5	56	22	5.5	8
GMF10022	M10	1.5	10	7	d1-1.8	70	24	5.5	8
GMF10023	M11	1.5	11	8	d1-2.8	70	24	6.2	9
GMF10024	M12	1.75	12	9	d1-2.1	75	29	7	10
GMF10025	M14	2	14	11	d1-2.4	80	30	9	12
GMF10026	M16	2	16	12	d1-2.4	80	32	9	12
GMF10027	M18	2.5	18	14	d1-3	95	40	11	14
GMF10028	M20	2.5	20	16	d1-3	95	40	12	15
GMF10029	M22	2.5	22	18	d1-3	100	40	14.5	17
GMF10030	M24	3	24	18	d1-3.6	110	50	14.5	17
GMF10031	M27	3	27	20	d1-3.6	110	50	16	19
GMF10032	M30	3.5	30	22	d1-4.2	125	56	18	21
GMF10033	M33	3.5	33	25	d1-4.2	125	56	20	23
GMF10034	M36	4	36	28	d1-4.8	150	63	22	25
GMF10035	M39	4	39	32	d1-4.8	150	63	24	27
GMF10036	M42	4.5	42	32	d1-5.4	150	63	24	27
GMF10037	M45	4.5	45	36	d1-5.4	160	70	29	32
GMF10038	M48	5	48	36	d1-6	180	75	29	32
GMF10039	M52	5	52	40	d1-6	180	75	32	35
GMF10040	M56	5.5	56	45	d1-6.6	200	85	35	38
GMF10041	M60	5.5	60	45	d1-6.6	200	85	35	38
GMF10042	M64	6	64	50	d1-7.2	220	90	39	38
GMF10043	M68	6	68	50	d1-7.2	220	90	39	38



Hand Tap Alloy Steel Imperial Size Standard

Art No.	Tap Size	P.per Inch
GMF11001	1/8	40
GMF11002	5/32	32
GMF11003	5/16	18
GMF11004	3/8	16
GMF11005	7/16	14
GMF11006	1/2	12
GMF11007	9/16	12
GMF11008	5/8	11
GMF11009	11/16	11
GMF11010	3/4	10
GMF11011	7/8	9
GMF11012	1	8



DIN 371/376 HSS Machine Tap

Art No.	Code	P	d1	d2	d3 (h13)	L1	L2	a (h12)	L
GMF12001	M1	0.25	1	2.5	d1-0.3	40	5.5	2.1	5
GMF12002	M1.1	0.25	1.1	2.5	d1-0.3	40	5.5	2.1	5
GMF12003	M1.2	0.25	1.2	2.5	d1-0.3	40	5.5	2.1	5
GMF12004	M1.4	0.3	1.4	2.5	d1-0.4	40	7	2.1	5
GMF12005	M1.6	0.35	1.6	2.5	d1-0.4	40	8	2.1	5
GMF12006	M1.7	0.35	1.7	2.5	d1-0.4	40	8	2.1	5
GMF12007	M1.8	0.35	1.8	2.5	d1-0.4	40	8	2.1	5
GMF12008	M2	0.4	2	2.8	d1-0.5	45	8	2.1	5
GMF12009	M2.2	0.45	2.2	2.8	d1-0.6	45	9	2.1	5
GMF12010	M2.3	0.4	2.3	2.8	d1-0.5	45	9	2.1	5
GMF12011	M2.5	0.45	2.5	2.8	d1-0.6	50	9	2.1	5
GMF12012	M2.6	0.45	2.6	2.8	d1-0.6	50	9	2.1	5
GMF12013	M3	0.5	3	3.5	d1-0.6	56	11	2.7	6
GMF12014	M3.5	0.6	3.5	4	d1-0.7	56	13	3	6
GMF12015	M4	0.7	4	4.5	d1-0.8	63	13	3.4	6
GMF12016	M4.5	0.75	4.5	6	d1-0.9	70	16	4.9	8
GMF12017	M5	0.8	5	6	d1-1	70	16	4.9	8
GMF12018	M6	1	6	6	d1-1.2	80	19	4.9	8
GMF12019	M7	1	7	6	d1-1.2	80	19	5.5	8
GMF12020	M8	1.25	8	7	d1-1.5	90	19	5.5	8
GMF12021	M9	1.25	9	7	d1-1.5	90	22	7	10
GMF12022	M10	1.5	10	8	d1-1.8	100	22	8	11
GMF12023	M12	1.5	12	9	d1-1.8	100	22	7	10
GMF12024	M14	1.5	14	9	d1-1.8	100	22	9	12
GMF12025	M16	1.5	16	12	d1-1.8	100	22	9	12
GMF12026	M18	1.5	18	14	d1-1.8	110	22	11	14
GMF12027	M20	1.5	20	16	d1-1.8	125	25	12	15
GMF12028	M24	2	24	18	d1-2.4	140	28	14	17



Machine Tap HSS Imperial Size Ground Pitch

Art No.	Tap Size	P.per Inch
GMF13001	1/8	40
GMF13002	5/32	32
GMF13003	5/16	18
GMF13004	3/8	16
GMF13005	7/16	14
GMF13006	1/2	12
GMF13007	9/16	12
GMF13008	5/8	11
GMF13009	11/16	11
GMF13010	3/4	10
GMF13011	7/8	9
GMF13012	1	8



Art No.	No. Size	For Screw
GMF14001	1	M3-M6
GMF14002	2	M6-M8
GMF14003	3	M8-M10
GMF14004	4	M11-M14
GMF14005	5	M14-M16
GMF14006	6	M16-M18
GMF14007	7	M24-M34
GMF14008	8	M34-M44
GMF14009	9	M44-M53
GMF14010	10	M53-M63



T-type-tap-rench

Art No.	Size	Length	Fo Hand M	Tap Size Ww	G
GMF15001	1#	85	M3-M10	1/8-3/8	
GMF15002	2#	100	M5-M12	7/32-1/2	6-1/8
GMF15003	10#	250	M3-M10	1/8-3/8	
GMF15004	20#	300	M5-M12	7/32-1/2	6-1/8



DIN225 Die Stock

mm

Art No.	Size	For Tap size		UNC/UNF	Pipe	Length
		Thickness	Metric			
GMF16001	16	5	M1-M2.6	1/16-3/32		160
GMF16002	20	5	M3-M4	1/8-5/32		200
GMF16003	20	7	M4.5-M6	3/16-1/4		200
GMF16004	25	9	M7-M9	5/16	G1/16	224
GMF16005	30	11	M10-M11	3/8-7/16	G1/8	280
GMF16006	38	10	MF12-MF14		G1/4	315
GMF16007	38	14	M12-M14	1/2-9/16		315
GMF16008	45	14	MF16-MF20		G3/8-G1/2	450
GMF16009	45	18	M16-M20	5/8-3/4		450
GMF16010	55	16	MF22-MF24		G5/8-G3/4	560
GMF16011	55	22	M22-M24	7/8-1		560
GMF16012	65	18	MF27-MF36		G7/8-G1	630
GMF16013	65	25	M27-M36	1-1/8-1-3/8		630
GMF16014	75	20	MF38-MF42		G1-1/8-G1-1/4	800
GMF16015	75	30	M38-M42	1-1/2-1-5/8		800
GMF16016	90	22	MF45-MF52		G1-3/8-G1-5/8	900
GMF16017	90	36	M45-M52	1-3/4-2		900
GMF16018	105	22	MF54-MF63		G1-3/4-2	1000
GMF16019	105	36	M54-M63	2-1/4-2-3/4		1000



HSS-G Fully Ground Combined Threading Bits

Art No.	Size	Pitch	Core Hole
GMF17001	M3	0.5	2.5
GMF17002	M4	0.7	3.3
GMF17003	M5	0.8	4.2
GMF17004	M6	1	5
GMF17005	M8	1.25	6.8
GMF17006	M10	1.5	8



DIN1814 Adjustable Tap Wrench

Art No.	Size	For Hand Tap Size		Pipe	Length
		Metric	UNC/UNF		
GMF18001	0	M1-M8	1/16-5/16		125
GMF18002	1	M3-M10	1/8-3/8		180
GMF18003	1-1/2	M3-M12	1/8-1/2	G1/8	200
GMF18004	2	M4-M12	3/16-5/8	G1/8-G3/8	280
GMF18005	3	M5-M20	1/4-3/4	G1/8-G1/2	375
GMF18006	4	M10-M27	3/8-1	G1/8-G3/4	500
GMF18007	5	M14-M33	5/8-1-1/4	G1/4-G1	750
GMF18008	6	M18-M42	3/4-1-1/2	G1/4-G1-1/4	1000
GMF18009	7	M25-M52	7/8-2	G5/8-G2-1/4	1250



DIN223 UNC/UNF

HSS And Alloy Steel Round Die

Art No.	Size	Outside
GMF20001	No.0-80NF	16 x 5
GMF20002	No.1-64NC	16 x 5
GMF20003	No.1-72NF	16 x 5
GMF20004	No.2-56NC	16 x 5
GMF20005	No.2-64NF	16 x 5
GMF20006	No.3-48NC	16 x 5
GMF20007	No.3-56NF	16 x 5
GMF20008	No.4-40NC	20 x 5
GMF20009	No.4-48NF	20 x 5
GMF20010	No.5-40NC	20 x 5
GMF20011	No.5-44NF	20 x 5
GMF20012	No.6-32NC	20 x 5
GMF20013	No.6-40NF	20 x 5
GMF20014	No.8-32NC	20 x 5
GMF20015	No.8-36NF	20 x 5
GMF20016	No.10-24NC	20 x 7
GMF20017	No.10-32NF	20 x 7
GMF20018	No.12-24NC	20 x 7
GMF20019	No.12-28NF	20 x 7
GMF20020	1/4-20NC	20 x 7
GMF20021	1/4-28NF	20 x 7
GMF20022	5/16-18NC	25 x 9
GMF20023	5/16-24NF	25 x 9
GMF20024	3/8-16NC	30 x 11
GMF20025	3/8-24NF	30 x 11



Art No.	Size	Outside
GMF20026	7/16-14NC	30 x 11
GMF20027	7/16-20NF	30 x 11
GMF20028	1/2-13NC	38 x 14
GMF20029	1/2-20NF	38 x 10
GMF20030	9/16-12NC	38 x 14
GMF20031	9/16-18NF	38 x 10
GMF20032	5/8-11NC	45 x 18
GMF20033	5/8-18NF	45 x 14
GMF20034	3/4-10NC	45 x 18
GMF20035	3/4-16NF	45 x 14
GMF20036	7/8-9NC	55 x 22
GMF20037	7/8-14NF	55 x 16
GMF20038	1-8NC	55 x 22
GMF20039	1-12NF	55 x 16
GMF20040	1-14NS	55 x 16
GMF20041	1-1/8-7NC	65 x 25
GMF20042	1-1/8-12NF	65 x 18
GMF20043	1-1/4-7NC	65 x 25
GMF20044	1-1/4-12NF	65 x 18
GMF20045	1-3/8-6NC	65 x 25
GMF20046	1-3/8-12NF	65 x 18
GMF20047	1-1/2-6NC	75 x 30
GMF20048	1-1/2-12NF	75 x 20
GMF20049	1-3/4-5NC	90 x 36
GMF20050	2-4-1/2NC	90 x 36



DIN223 HSS And Alloy Steel Round Die

Art No.	Thread	Pitch	Outside	Art No.	Thread	Pitch	Outside
GMF19001	M1	0.2	16 x 5	GMF19065	M10	0.5	30 x 11
GMF19002	M1	0.25	16 x 5	GMF19066	M10	0.75	30 x 11
GMF19003	M1.2	0.2	16 x 5	GMF19067	M10	1	30 x 11
GMF19004	M1.2	0.25	16 x 5	GMF19068	M10	1.25	30 x 11
GMF19005	M1.4	0.2	16 x 5	GMF19069	M10	1.5	30 x 11
GMF19006	M1.4	0.25	16 x 5	GMF19070	M11	0.5	30 x 11
GMF19007	M1.4	0.3	16 x 5	GMF19071	M11	0.75	30 x 11
GMF19008	M1.6	0.2	16 x 5	GMF19072	M11	1	30 x 11
GMF19009	M1.6	0.25	16 x 5	GMF19073	M11	1.25	30 x 11
GMF19010	M1.6	0.35	16 x 5	GMF19074	M11	1.5	30 x 11
GMF19011	M1.7	0.2	16 x 5	GMF19075	M12	0.5	38 x 10
GMF19012	M1.7	0.25	16 x 5	GMF19076	M12	0.75	38 x 10
GMF19013	M1.7	0.35	16 x 5	GMF19077	M12	1	38 x 10
GMF19014	M1.8	0.2	16 x 5	GMF19078	M12	1.25	38 x 10
GMF19015	M1.8	0.25	16 x 5	GMF19079	M12	1.5	38 x 10
GMF19016	M1.8	0.35	16 x 5	GMF19080	M12	1.75	38 x 10
GMF19017	M2	0.2	16 x 5	GMF19081	M14	0.5	38 x 10
GMF19018	M2	0.25	16 x 5	GMF19082	M14	0.75	38 x 10
GMF19019	M2	0.35	16 x 5	GMF19083	M14	1	38 x 10
GMF19020	M2	0.4	16 x 5	GMF19084	M14	1.25	38 x 10
GMF19021	M2.2	0.25	16 x 5	GMF19085	M14	1.5	38 x 10
GMF19022	M2.2	0.35	16 x 5	GMF19086	M14	2	38 x 14
GMF19023	M2.2	0.45	16 x 5	GMF19087	M15	0.5	38 x 10
GMF19024	M2.3	0.25	16 x 5	GMF19088	M15	0.75	38 x 10
GMF19025	M2.3	0.35	16 x 5	GMF19089	M15	1	38 x 10
GMF19026	M2.3	0.4	16 x 5	GMF19090	M15	1.5	38 x 10
GMF19027	M2.5	0.25	16 x 5	GMF19091	M16	0.5	45 x 14
GMF19028	M2.5	0.35	16 x 5	GMF19092	M16	0.75	45 x 14
GMF19029	M2.5	0.45	16 x 5	GMF19093	M16	1	45 x 14
GMF19030	M2.6	0.25	16 x 5	GMF19094	M16	1.25	45 x 14
GMF19031	M2.6	0.35	16 x 5	GMF19095	M16	1.5	45 x 14
GMF19032	M2.6	0.45	16 x 5	GMF19096	M16	2	45 x 18
GMF19033	M3	0.25	20 x 5	GMF19097	M18	0.5	45 x 14
GMF19034	M3	0.35	20 x 5	GMF19098	M18	0.75	45 x 14
GMF19035	M3	0.5	20 x 5	GMF19099	M18	1	45 x 14
GMF19036	M3.5	0.25	20 x 5	GMF19100	M18	1.5	45 x 14
GMF19037	M3.5	0.35	20 x 5	GMF19101	M18	2	45 x 14
GMF19038	M3.5	0.5	20 x 5	GMF19102	M18	2.5	45 x 18
GMF19039	M3.5	0.6	20 x 5	GMF19103	M20	0.5	45 x 14
GMF19040	M4	0.35	20 x 5	GMF19104	M20	0.75	45 x 14
GMF19041	M4	0.5	20 x 5	GMF19105	M20	1	45 x 14
GMF19042	M4	0.7	20 x 5	GMF19106	M20	1.25	45 x 14
GMF19043	M4.5	0.35	20 x 5	GMF19107	M20	1.5	45 x 14
GMF19044	M4.5	0.5	20 x 5	GMF19108	M20	2	45 x 14
GMF19045	M4.5	0.7	20 x 7	GMF19109	M20	2.5	45 x 18
GMF19046	M5	0.35	20 x 5	GMF19110	M22	0.5	55 x 16
GMF19047	M5	0.5	20 x 5	GMF19111	M22	0.75	55 x 16
GMF19048	M5	0.75	20 x 7	GMF19112	M22	1	55 x 16
GMF19049	M5	0.8	20 x 7	GMF19113	M22	1.5	55 x 16
GMF19050	M6	0.35	20 x 5	GMF19114	M22	2	55 x 16
GMF19051	M6	0.5	20 x 5	GMF19115	M22	2.5	55 x 22
GMF19052	M6	0.75	20 x 7	GMF19116	M24	3	55 x 22
GMF19053	M6	1	20 x 7	GMF19117	M25	0.5	55 x 16
GMF19054	M7	0.5	25 x 9	GMF19118	M25	0.75	55 x 16
GMF19055	M7	0.75	25 x 9	GMF19119	M25	1	55 x 16
GMF19056	M7	1	25 x 9	GMF19120	M25	1.5	55 x 16
GMF19057	M8	0.5	25 x 9	GMF19121	M25	2	55 x 16
GMF19058	M8	0.75	25 x 9	GMF19122	M27	3	65 x 25
GMF19059	M8	1	25 x 9	GMF19123	M30	0.5	65 x 18
GMF19060	M8	1.25	25 x 9	GMF19124	M30	1	65 x 18
GMF19061	M9	0.5	25 x 9	GMF19125	M30	1.5	65 x 18
GMF19062	M9	0.75	25 x 9	GMF19126	M30	2	65 x 18
GMF19063	M9	1	25 x 9	GMF19127	M30	3	65 x 25
GMF19064	M9	1.25	25 x 9	GMF19128	M30	3.5	65 x 25



Remark: M32-M68 available upon request



GMF001

12pcs Metric tap and die set

Packing: metal case

5pcs taps/dies: 6 x 1.0, 7 x 1.0, 8 x 1.25,
10 x 1.5, 12x1.75

1pc tap wrench: M3-M12

1pc die wrench: 25mm O/D



GMF002

20pcs SAE tap and die set

Packing: Metal case

Contents:

9 Taps/Dies:6-32,8-32,10-24,1/4-20,5/16-18,3/8-16,
7/16-14,1/2-13,1/8-27,1/8-27

1 Tap wrench:1/16-1/2"

1 Die wrench:1" O/D



GMF003

60pcs Metric & inch tap and die set

Packing: metal case

27pcs taps/dies: 3 x 0.5, 4 x 0.7, 5 x 0.8, 6 x 1.0, 7 x 1.0,
8 x 1.25, 9 x 1.25, 10 x 1.5, 10 x 1.0,
12 x 1.75, 4-40, 6-32, 8-32, 10-24, 10-32,
12-24, 1/4-20, 1/4-28, 5/16-18, 5/16-24,
3/8-16, 3/8-24, 7/16-14, 7/16-20, 1/2-13,
1/2-20, 1/8-27

1pc tap wrench: M4-M12 (1/16-1/2")

1pc T-type tap wrench: M3-M6 (1/16-1/4")

1pc die wrench: 25mm (1") O/D

1pc screwdriver, 1pc metric scw pitch gague,

1pc inch screw pitch gague



GMF004

110pcs Metic & inch tap and die set

Packing: metal case

35pcs taper taps: 6 x 1.0, 8 x 1.25, 10 x 1.5, 10 x 1.0, 11 x 1.5,
12 x 1.75, 12 x 1.25, 14 x 1.25, 18 x 1.5, 4-40,
6-32, 8-32, 10-24, 10-32, 12-24, 1/4-20, 1/4-24,
1/4-28, 1/4-32, 5/16-18, 5/16-24, 3/8-16, 3/8-24,
7/16-14, 7/16-20, 1/2-13, 1/2-20, 9/16-12, 9/16-18,
5/8-18, 5/8-11, 3/4-16, 3/4-10, 1/8-27, 1/4-18

35pcs plug taps: sizes as taper taps

35pcs dies: sizes as taps

2pcs tap wrench: 1/16-1/2", 1/4-3/4"

2pcs die wrench: 1", 1/2" OD

1pc T-type tap wrench: 1/16-1/4"



GMF005

24pcs SAE tap and die set

Packing: metal case

11pcs taps/dies: 1/4-20, 1/4-28, 5/16-18, 5/16-24,
3-8/16, 3/8-24, 7/16-14, 7/16-20,
1/2-13, 1/2-20, 1/8-27

1pc tap wrench: 1/16-1/2"

1pc die wrench: 1" O/D



GMF006

40pcs Inch tap and die set

Packing: metal case

16pcs taps/dies: 4-40, 6-32, 8-32, 10-24, 10-32, 12-24, 1/4-20,
1/4-28, 5/16-18, 5/16-24, 3/8-16, 3/8-24,
7/16-14, 7/16-20, 1/2-13, 1/2-20;

1pc NPT tap: 1/8-27

1pc NPT die: 1/8-27

1pc tap wrench: 1/16-1/2"

1pc T-type tap wrench: 1/16-1/4"

1pc die wrench: 1" O/D

1pc screwdriver

1pc screw pitch gauge



GMF007

20pcs SAE tap and die set

Packing: blow case

9pcs taps/dies: 6-32, 8-32, 10-24, 1/4-20, 5/16-18,
3/8-16, 7/16-14, 1/2-13

1pc tap wrench: 1/16-1/2"

1pc die wrench: 1" O/D



GMF008

40pcs SAE tap and die set

Packing: blow case

17pcs taps/dies: 4-40, 6-32, 8-32, 10-24, 12-24, 10-32,
1/4-20, 1/4-28, 5/16-18, 5/16-24, 3/8-16, 3/8-24,
7/16-14, 7/16-20, 1/2-13, 1/2-20, 1/8-27



GMF009

12pcs Metric tap and die set

Packing: plastic case

5pcs taps/dies: 6 x 1.0, 7 x 1.0, 8 x 1.25,
10 x 1.5, 12 x 1.75

1pc tap wrench: M3-M12

1pc die wrench: 25mm O/D



GMF010

20pcs Metric tap and die set

Packing: plastic case

9pcs taps/dies: 3 x 0.5, 4 x 0.7, 5 x 0.8,
6 x 1.0, 7 x 1.0, 8 x 1.25,
9 x 1.25, 10 x 1.5, 12 x 1.75

1pc tap wrench: M3-M12

1pc die wrench: 25mm O/D



GMF011

45pcs Metric tap and die set

Packing: below case

20pcs taps/dies: 6 x 0.75, 6 x 1.0, 8 x 1.25, 8 x 1.0, 10 x 1.5,
10 x 1.25, 12 x 1.75, 12 x 1.5, 14 x 2.0,
14 x 1.5, 16 x 2.0, 16 x 1.5, 18 x 2.5,
18 x 1.5, 20 x 2.5, 20 x 1.5, 22 x 2.5,
22x1.5, 24x3.0, 24x1.5

1pc tap wrench: M8-M25

1pc T-type tap wrench: M3-M6

1pc die wrench: 50mm O/D

1pc adapters for die wrench: 38mm O/D

1pc screwdriver



GMF012

60pcs Metric & inch tap and die set

Packing: below case

27pcs taps/dies: 3 x 0.5, 4 x 0.7, 5 x 0.8, 6 x 1.0, 7 x 1.0, 8 x 1.25,
9 x 1.25, 10 x 1.5, 10 x 1.0, 12 x 1.75, 4-40, 6-32,
8-32, 10-24, 12-24, 10-32, 1/4-20, 1/4-28, 5/16-18,
5/16-24, 3/8-16, 3/8-24, 7/16-14, 7/16-20,
1/2-13, 1/2-20, 1/8-27

1pc tap wrench: M4-M12 (3/16-1/2")

1pc T-type tap wrench: M3-M6 (1/16-1/4")

1pc die wrench: 25mm (1") O/D

1pc screwdriver, 1pc metric screw pitch gauge,

1pc inch screw pitch gauge



DIN327 HSS/ Solid Carbide 2 Flutes End Mills

DIN844 HSS/Solid Carbide 4 Flutes End Mills

mm				
Art No.	Dia Mill	Dia Shk	L2 Flute	L1 Oal
GMG10001	1	6	3	47
GMG10002	1.5	6	4	48
GMG10003	2	6	4	48
GMG10004	2.5	6	5	49
GMG10005	3	6	5	49
GMG10006	4	6	7	51
GMG10007	4.5	6	8	52
GMG10008	5	6	8	52
GMG10009	5.5	6	8	52
GMG10010	6	6	8	52
GMG10011	6.5	10	10	60
GMG10012	7	10	10	60
GMG10013	7.5	10	11	61
GMG10014	8	10	11	61
GMG10015	8.5	10	13	63
GMG10016	9	10	13	63
GMG10017	10	10	13	63
GMG10018	11	12	16	73
GMG10019	12	12	16	73
GMG10020	13	12	16	73
GMG10021	14	12	16	73
GMG10022	15	12	16	73
GMG10023	16	16	19	79
GMG10024	17	16	19	79
GMG10025	18	16	19	79
GMG10026	20	20	22	88
GMG10027	21	20	22	88
GMG10028	22	20	22	88
GMG10029	23	20	22	88
GMG10030	24	26	26	102
GMG10031	25	26	26	102
GMG10032	26	26	26	102
GMG10033	28	26	26	102
GMG10034	30	26	26	102
GMG10035	32	32	32	102

mm				
Art No.	Dia Mill	Dia Shk	L2 Flute	L1 Oal
GMG11001	1.5	6	7	51
GMG11002	2	6	7	51
GMG11003	3	6	8	52
GMG11004	4	6	11	55
GMG11005	5	6	13	57
GMG11006	6	6	13	57
GMG11007	7	10	16	66
GMG11008	8	10	19	69
GMG11009	9	10	19	69
GMG11010	10	10	22	72
GMG11011	11	12	22	79
GMG11012	12	12	26	83
GMG11013	13	12	26	83
GMG11014	14	12	26	83
GMG11015	15	12	26	83
GMG11016	16	16	32	92
GMG11017	17	16	32	92
GMG11018	18	16	32	92
GMG11019	20	20	38	104
GMG11020	21	20	38	104
GMG11021	22	20	38	104
GMG11022	23	20	45	104
GMG11023	24	25	45	121
GMG11024	25	25	45	121
GMG11025	26	25	45	121
GMG11026	28	25	45	121
GMG11027	30	25	45	121
GMG11028	32	32	53	133

Remark: bright finished, same dia and shank available upon request.





DIN844 HSS/Solid Carbide 4 Flutes Long End Mills

mm

Art No.	Dia Mill	Dia Shk	L2 Flute	L1 Oal
GMG12001	2	6	10	54
GMG12002	3	6	12	56
GMG12003	4	6	19	63
GMG12004	5	6	24	68
GMG12005	6	6	24	68
GMG12006	7	10	30	80
GMG12007	8	10	38	88
GMG12008	10	10	45	95
GMG12009	12	12	53	110
GMG12010	14	12	53	110
GMG12011	16	16	63	123
GMG12012	18	16	63	123
GMG12013	20	20	75	141
GMG12014	22	20	75	141
GMG12015	25	25	90	166
GMG12016	28	25	90	166
GMG12017	30	25	90	166
GMG12018	32	32	106	186



HSS 2 Flutes Single End Mills Regular Length

Art No.	Dia Mill	Dia Shk	L1 Oal	L2 Flute
GMG13001	1/16	1/16	1-1/2	1/4
GMG13002	1/16	1/8	1-1/2	1/4
GMG13003	3/32	1/8	1-1/2	3/8
GMG13004	1/8	1/8	1-1/2	1/2
GMG13005	1/8	3/8	2-5/16	3/8
GMG13006	5/32	3/16	2	9/16
GMG13007	3/16	3/16	2	5/8
GMG13008	3/16	3/8	2-5/16	7/16
GMG13009	7/32	1/4	2-1/2	5/8
GMG13010	1/4	1/4	2-1/2	3/4
GMG13011	1/4	3/8	2-5/16	1/2
GMG13012	9/32	5/16	2-1/2	3/4
GMG13013	5/16	5/16	2-1/2	13/16
GMG13014	5/16	3/8	2-5/16	9/16
GMG13015	3/8	3/8	2-1/2	7/8
GMG13016	3/8	3/8	2-5/16	9/16
GMG13017	7/16	7/16	2-1/2	7/8
GMG13018	7/16	3/8	2-1/2	13/16
GMG13019	1/2	1/2	3	1
GMG13020	9/16	9/16	3	1-1/4
GMG13021	9/16	1/2	3-1/8	1-1/8

Art No.	Dia Mill	Dia Shk	L1 Oal	L2 Flute
GMG13022	5/8	5/8	3-1/2	1-1/4
GMG13023	5/8	1/2	3-1/8	1-1/8
GMG13024	5/8	5/8	3-7/16	1-5/16
GMG13025	11/16	3/4	4	1-1/2
GMG13026	11/16	5/8	3-7/16	1-5/16
GMG13027	3/4	1/2	3-7/16	1-5/16
GMG13028	3/4	3/4	4	1-1/2
GMG13029	3/4	5/8	3-7/16	1-5/16
GMG13030	3/4	3/4	3-9/16	1-5/16
GMG13031	13/16	5/8	3-5/8	1-1/2
GMG13032	7/8	5/8	3-5/8	1-1/2
GMG13033	7/8	3/4	3-3/4	1-1/2
GMG13034	7/8	7/8	3-3/4	1-1/2
GMG13035	15/16	3/4	3-3/4	1-1/2
GMG13036	1	5/8	3-5/8	1-1/2
GMG13037	1	3/4	3-3/4	1-1/2
GMG13038	1	7/8	4-1/8	1-5/8
GMG13039	1-1/8	1	4-1/8	1-5/8
GMG13040	1-1/4	1	4-1/8	1-5/8
GMG13041	1	1	4	1-1/2

Presentation: bright finished.

**HSS 2 Flutes Double End Mills**

Art No.	Dia Mill	Dia Shk	L1 Oal	L2 Flute
GMG14001	1/8	3/8	3-1/16	3/8
GMG14002	5/32	3/8	3-1/8	7/16
GMG14003	3/16	3/8	3-1/8	7/16
GMG14004	7/32	3/8	3-1/8	1/2
GMG14005	1/4	3/8	3-1/8	1/2
GMG14006	9/32	3/8	3-1/8	9/16
GMG14007	5/16	3/8	3-1/8	9/16
GMG14008	11/32	3/8	3-1/8	9/16
GMG14009	3/8	3/8	3-1/8	9/16
GMG14010	13/32	1/2	3-3/4	13/16
GMG14011	7/16	1/2	3-3/4	13/16
GMG14012	15/32	1/2	3-3/4	13/16
GMG14013	1/2	1/2	3-3/4	13/16
GMG14014	9/16	5/8	4-1/2	1-1/8
GMG14015	5/8	5/8	4-1/2	1-1/8
GMG14016	11/16	3/4	5	1-5/16
GMG14017	3/4	3/4	5	1-5/16
GMG14018	7/8	7/8	5-1/2	1-9/16
GMG14019	15/16	1	5-7/8	1-5/8
GMG14020	1	1	5-7/8	1-5/8

**HSS 4 Flutes Double End Mills (Center Cutting)**

Art No.	Dia	Dia Shk	L2 Flute	L1 Oal
GMG15001	1/8	3/8	3/8	2-5/16
GMG15002	3/16	3/8	1/2	2-3/8
GMG15003	1/4	3/8	5/8	2-7/16
GMG15004	5/16	3/8	3/4	2-1/2
GMG15005	3/8	3/8	3/4	2-1/2
GMG15006	1/2	1/2	1-1/4	3-1/4
GMG15007	5/8	5/8	1-5/8	3-3/4
GMG15008	3/4	3/4	1-5/8	3-7/8
GMG15009	7/8	7/8	1-7/8	4-1/8
GMG15010	1	1	2	4-1/2

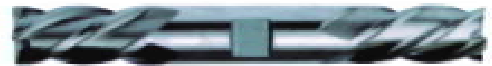

Remark: precision ground, bright finished.



GMG001

5pcs Roughing end mills set

4 flute

Package: wooden box

Size: 10mm-12mm-16mm--20mm-25mm



GMG002

9pcs Tin HSS ball nose end mills set

2 flute, DIN327

Package: wooden box

Size: 3mm-5m-6mm-8mm-10mm-12mm-
14mm-16mm-20mm



GMG003

9pcs Tin HSS ball nose end mills set

ANSI Standard, center Cutting

Package: wooden box

Size: 1/16" - 5/64" - 3/32" - 7/64" - 1/8" - 9/64" - 5/32" -
11/64" - 3/16" with 3/16" shank



GMG004

20pcs Inch tin HSS end mills set ANSI standar

Package: wooden box

Size: 10pcs each 4 flute: 3/16" x 3/8", 1/4"x3/8",
5/16" x 3/8", 3/8" x 3/8", 7/16" x 3/8", 1/2" x 1/2",
9/16" x 1/2", 5/8" x 5/8", 11/16" x 5/8", 3/4" x 3/4",
10pcs each 2 flute: 3/16" x 3/8", 1/4" x 3/8",
5/16" x 3/8", 3/8" x 3/8", 7/16" x 3/8", 1/2" x 1/2",
9/16" x 1/2", 5/8" x 5/8", 11/16" x 5/8", 3/4" x 3/4"

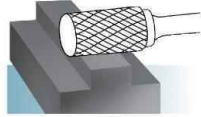

GMH10001

SA: Cylindrical-standard

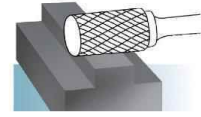

GMH11001

SB: Cylindrical End Cut-standard



GMH12001

SC: Cylindrical Ball Nose-standard

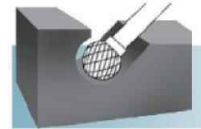

GMH13001

SD: Round (Ball)-standard

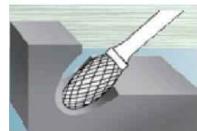

GMH14001

SE: Oval (Egg)-standard

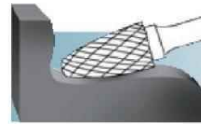

GMH15001

SF: Round Tree-standard

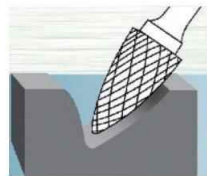

GMH16001

SG: Pointed Tree-standard

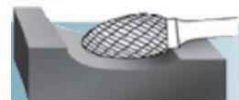

GMH17001

SH: Flame-standard

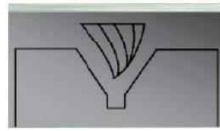

GMH18001

SJ: 60° Included Angle Countersink-standard

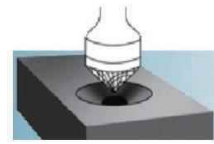

GMH19001

SK: 90° Included Angle Countersink-standard



GMH20001

SL: 14° Included Angle-standard



GMH21001

SM: Cone-standard

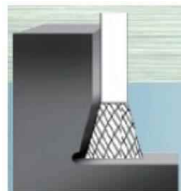

GMH22001

SN: Inverted Cone-standard



GMH23001

SS: Flat End Taper-metric



GMH24001

SX: Carbide Thin Disc-metric



GMH25001

SR: Cylindric-metric



GMH26001

Shape GA & MA



GMH27001

Cup brushes, crimped wire



GMH28001

Cup brushes, knot wire



GMH29001

Cup brushes, crimped wire



GMH30001

Cup brushes, knot wire



GMH31001

Cup brushes, crimped wire



GMH32001

Bevel brushes, knot wire



GMH33001

Wide face wheel brushes, crimped wire



GMH34001

Bevel brushes, knot wire



GMH35001

Wide face wheel brushes, crimped wire



GMH36001

End brushes, crimped wire



GMH37001

Knife brushes, crimped wire



Calcined Aluminium Oxide Flap for Steel T27 or T29

mm

Art No.	Dia.	Inner Hole
GMH38001	100	16
GMH38002	100	16
GMH38003	100	16
GMH38004	100	16
GMH38005	115	22
GMH38006	115	22
GMH38007	115	22
GMH38008	115	22
GMH38009	125	22
GMH38010	125	22
GMH38011	125	22
GMH38012	125	22
GMH38013	125	22
GMH38014	150	22
GMH38015	150	22
GMH38016	150	22
GMH38017	180	22
GMH38018	180	22
GMH38019	180	22
GMH38020	180	22



Zirconia Abrasive Flap Disc T27 or T29

mm

Art No.	Dia.	Inner Hole
GMH39001	100	16
GMH39002	100	16
GMH39003	100	16
GMH39004	100	16
GMH39005	115	22
GMH39006	115	22
GMH39007	115	22
GMH39008	115	22
GMH39009	125	22
GMH39010	125	22
GMH39011	125	22
GMH39012	125	22
GMH39013	125	22
GMH39014	150	22
GMH39015	150	22
GMH39016	150	22
GMH39017	180	22
GMH39018	180	22
GMH39019	180	22
GMH39020	180	22





GMH001

5pcs Carbide burrs set

Shank dia: 6mm or 6.35mm

Model: L1228, N1213, M1225, C1225, G1225



GMH002

5pcs Carbide burrs set

Shank dia: 6mm or 6.35mm

Model: C0820, F1020, B1020, L1228, G1225



GMH003

5pcs Carbide burrs set

Shank dia: 6mm or 6.35mm

Model: A1020, C1020, D1009, E1016, F1020



GMH004

6pcs Carbide burrs set

Shank Dia: 6mm or 6.35mm

Model: J1210, D1210, C1225, E1220, G1225, N1213



GMH005

8pcs Carbide burrs set

Shank Dia: 6mm or 6.35mm

Model: D1210, D1009, F1225, F1020, C1225, C1020, A1225, A1020



GMH006

8pcs Carbide burrs set

Shank Dia: 3/32", 3mm or 1/8"

Model: D0403, D0605, A0413, A0613, C0613, C0413, F0618, F0618



GMH007

8pcs Carbide burrs set

Shank dia: 6mm or 6.35mm

Model: J1210, F1020, D0807, D0605, C0616,
C1020, A1020, A1225



GMH008

9pcs Carbide burrs set

Shank dia: 6mm or 6.35mm

Model: A1225, A1020, C1225, C1020, F1225,
F1020, A0616, C0616, F0616



GMH009

9pcs Carbide burrs set

Shank dia: 6mm or 6.35mm

Model: A0820, G1020, C0820, F0820, E1016,
L0822, N0607, C0616, F1020



GMH010

10pcs Carbide burrs set

Shank dia: 6mm or 6.35mm

Model: A1225, C1225, L1228, E1220, G1225,
C1020, N1213, E1016, K1005, D1009



GMH011

10pcs Carbide burrs set

Shank dia: 6mm or 6.35mm

Model: A1225, H1232, L1228, F1225, E1220,
A1020, H1025, C1020, G1020, D1009



GMH012

5pcs Carbide burrs set

Shank dia: 2.35mm

Model: A0613, G0613, L0413, L0213, A0604



GMH013

15pcs Carbide burrs set

Shank dia: 3/32", 3mm or 1/8"

Model: N0304, E0306, H0307, A0313, C0313,
G0310, L0310, M0311, D0605, N0607,
E0610, L0613, A0616, L0616, F0618



GMH014

50pcs Carbide burrs set

Shape: R

Shank dia: 1/8"

Head dia: 1mm, 1.2mm, 1.4mm, 1.5mm, 2.0mm



GMH015

10pcs Diamond mounted point set

Grit: #150, #200

Total length: 45mm

Shank dia: 2.35/3/3.17mm



GMH016

20pcs Diamond mounted point set

Grit: #150, #200

Total length: 45mm

Shank dia: 2.35/3/3.17mm



GMH017

15pcs Diamond mounted point set

Grit: #150, #200

Total length: 45mm

Shank dia: 2.35/3/3.17mm



GMH018

25pcs Diamond mounted point set

Grit: #150, #200

Total length: 45mm

Shank dia: 2.35/3/3.17mm





GMH019

30pcs Diamond mounted point set

Grit: #150, #200
Total length: 45mm
Shank dia: 2.35/3/3.17mm



GMH020

30pcs Diamond mounted point set

Grit: #150, #200
Total length: 45mm
Shank dia: 2.35/3/3.17mm



GMH021

50pcs Diamond mounted point set

Grit: #150, #200
Shand dia: 3.17mm



GMH022

40pcs Electric rotary tool set

Include: 11pcs grinding wheel with shank, 5pcs regular cut-off wheel, 1pc sanding disc wheel, 1pc screw mandrel, 2pcs felt wheel, 1pc sanding drum, 4pcs sanding band, 6pcs sanding paper, 3pcs diamond pointed wheel, 1pc dress stone, 1pc collect, 1pc wrench, 1pc HSS twist drill, 1pc flexible shaft, 1pc stander



GMH023

161pcs Electric rotary tool set

Include: 22pcs sanding band, 5pcs felt wheel, 1pc felt pointed wheel, 1pc cloth wheel, 1pc rubber emery wheel, 6pcs HSS twist drill, 2pcs sanding drum, 7pcs diamond pointed wheel, 3pcs HSS cutter, 10pcs frinding wheel with shank, 9pcs brush, 2pcs polish compound, 32pcs heavy duty cut-off wheel, 32pcs regular cut-off wheel, 4pcs collect, 12pcs grinding wheel, 1pc dress stone, 4pcs screw mandrel, 1pc flap wheel, 5pcs fiberglass cut-off wheel, 1pc wrench



GMH024

72pcs Rotary tool set

Include: 6pcs mini-sanding bands, 10pcs felt wheel, 1pc bullet shaped felt wheel 3/8", 1pc buffing wheel dia 1", 2pcs rubber sanding drums, 4pcs assorted diamond points, 1pc cylindrical HSS rotary files, 4pcs mounted grinding point, 2pcs carbon steel wheel brush, 1pc polishing paste in bottle, green, 36pcs sanding paper disc in bottle, 2pcs collect, 1pc 1/16" mandrel for cut off wheel, 1pc mandrel for felt wheel